



CMP CABLE GLANDS & ACCESSORIES

AMERICAS PRODUCT CATALOG



WHAT WE PROMISE FOR YOUR BUSINESS

CMP PRODUCTS IS A MARKET LEADING SPECIALIST DESIGNER, MANUFACTURER, AND SUPPLIER OF CABLE GLANDS, CABLE CLEATS AND ACCESSORIES.

Established as part of British Engines group in 1957, we have ensured that our customers remain at the heart of everything that we do, wherever they are around the world.

We believe in setting standards for quality and service, and leading the way in product innovation, whilst maintaining integrity, safety and reliability. This means that whether our products are used for onshore or offshore oil and gas installations, in power generation, transportation infrastructure, or for surface or underground mining applications, they always protect the safety of your people and your infrastructure.

By remaining focused on this commitment to our customers, our business has grown to become a world leader in our market, continuing to provide assurance of the highest standards of quality and service.

INNOVATION IN PRODUCTS & SOLUTIONS

Evolving technical standards and stringent certification processes have helped to drive innovation at CMP. As a market leader in cable gland and cable cleat technology, we invest heavily in advanced manufacturing techniques, dedicated IT systems and effective training for our employees and customers.

The solutions chosen by our customers are often rigorously tested to perform above and beyond the normal standards, since they are used in progressively demanding applications and environments.

PEOPLE & NETWORKS

CMP's structure allows us the flexibility to meet these continuously evolving needs, and we nurture this culture further by recruiting specialist, highly talented people in all areas of our business.

We have also formed excellent relationships with the people and organizations that do business with us, developing alliances with distributors and end-users internationally. This network is key to our strategy for bringing products to a worldwide market, via a strategic global distribution network reflective of our business.

CUSTOMER CARE

Putting the customer at the centre of what we do and ensuring a positive experience for everyone we work with is a vital part of our vision.

AN INTRODUCTION TO CABLE GLANDS

CABLE GLANDS ARE MECHANICAL CABLE ENTRY DEVICES, WHICH CAN BE CONSTRUCTED FROM METALLIC OR NON-METALLIC MATERIALS OR A COMBINATION OF BOTH.

They are used throughout all industries in conjunction with cable and wiring used in electrical, instrumentation, control and automation systems.

Cable Glands may be used on all types of electrical power, control, instrumentation, data and telecommunications cables and are used as sealing/terminating devices to ensure that the characteristics of the enclosure which the cable enters can be safely maintained. The main functions of the Cable Gland, depending on type, are listed briefly as follows:

- Provide environmental protection by sealing on the outer cable sheath, excluding dust and moisture from the electrical or instrument enclosure.
- In the case of armored cables facilitate ground continuity, when the Cable Gland has a metallic construction. In this case Cable Glands may be tested to ensure that they can withstand a minimum short circuit fault current, corresponding to that of the cable armor or peak fault of the electrical system.
- Provide a holding force on the cable to ensure adequate levels of cable pull-out resistance, and prevent lateral and axial loads being applied to the internal cable conductor terminations.
- Provide additional sealing on the part of the cable entering the enclosure, when a high degree of ingress protection is required.
- Provide additional environmental sealing at the cable entry point, maintaining the ingress protection rating of the enclosure and cable gland combination, with the selection of applicable accessories dedicated to performing this function.
- Constructed from corrosion-resistant materials determined by selection to a technical standard, or by corrosion resistance tests.

When used in explosive atmospheres it is crucial that Cable Glands are selected correctly according to the specified installation code or standard requirements, taking into account any certification limitations or conditions of use; are approved for the type of cable selected, and maintain the level of protection of the equipment to which they are attached.

WHY CHOOSE CMP PRODUCTS?

QUALITY ASSURANCE & RELIABILITY

CMP PRODUCTS HAS AN INTERNATIONAL REPUTATION FOR QUALITY AND RELIABILITY AND IS HIGHLY REGARDED AS THE LEADING SPECIALIST IN THE DESIGN AND MANUFACTURE OF CABLE GLANDS AND ACCESSORIES FOR GENERAL PURPOSE AND HAZARDOUS LOCATIONS.

This position as market leader is maintained by listening to our customers and understanding their needs, to ensure that our solutions are practical to install and fully compliant with the latest industry standards and specifications.

In recognition of the need to demonstrate and maintain standards, CMP Products has attained approval as a 'quality assured' company, covering the design and manufacture of Cable Glands, Cable Cleats and associated accessories. Our Quality Management System is approved to ISO 9001 : 2008 and Environmental Management System ISO 14001 with our 3rd party periodic audit and ongoing approval is performed by Bureau Veritas.

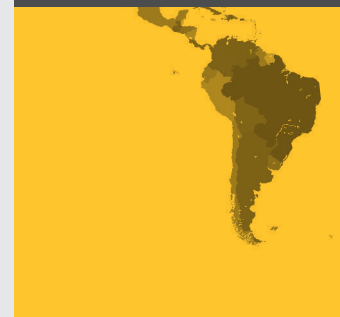

RESEARCH & DEVELOPMENT

Research and development (R&D) is fundamental to the successful advances made with our product innovations and is a major contributor to helping customers achieve reciprocal success, whilst setting CMP apart from the rest of the market. R&D at CMP Products is powered by an engineering community of highly skilled technical experts in several locations around the world.

Such a comprehensive R&D team allows us to create bespoke solutions to meet the needs of our customers, which in turn can be thoroughly tested in our on-site certified laboratory and then third party certified if required.

COMPLIANCE WITH CURRENT STANDARDS

CMP Products leads the way in the application of technical standards and with a dedicated certification team we design, manufacture and supply products that are compliant with all of the latest standards for NEC, CEC and IEC based installations.

TECHNICAL SUPPORT & TRAINING

With several offices spread across six continents including Europe, the Americas, Australia, Asia and Africa we are able to satisfy the worldwide demand for comprehensive training in the installation of our products.

Attendees at all CMP training courses will receive a certificate of proficiency following successful completion. We also provide installation videos, as well as technical support and practical demonstrations at your premises or on-site.

GLOBAL CERTIFICATION

CMP Products remains in constant touch with the development of national and international technical standards, and consequently is able to offer product solutions that are certified for multiple applications around the world. This entails a number of single off-the-shelf product solutions marked with Global Certification as standard.

INTERNATIONAL EXPLOSIVE ATMOSPHERES APPROVALS HELD INCLUDE CCSAUS, CSA, UL, ATEX, IECEX, INMETRO, KCS, NEPSI, CIDET, CCOE / PESO, RETIE, EAC AND MARINE APPROVALS.



CMP PRODUCTS CABLE GLANDS - THE KEY FEATURES

TYPICAL CMP BARRIER CABLE GLAND

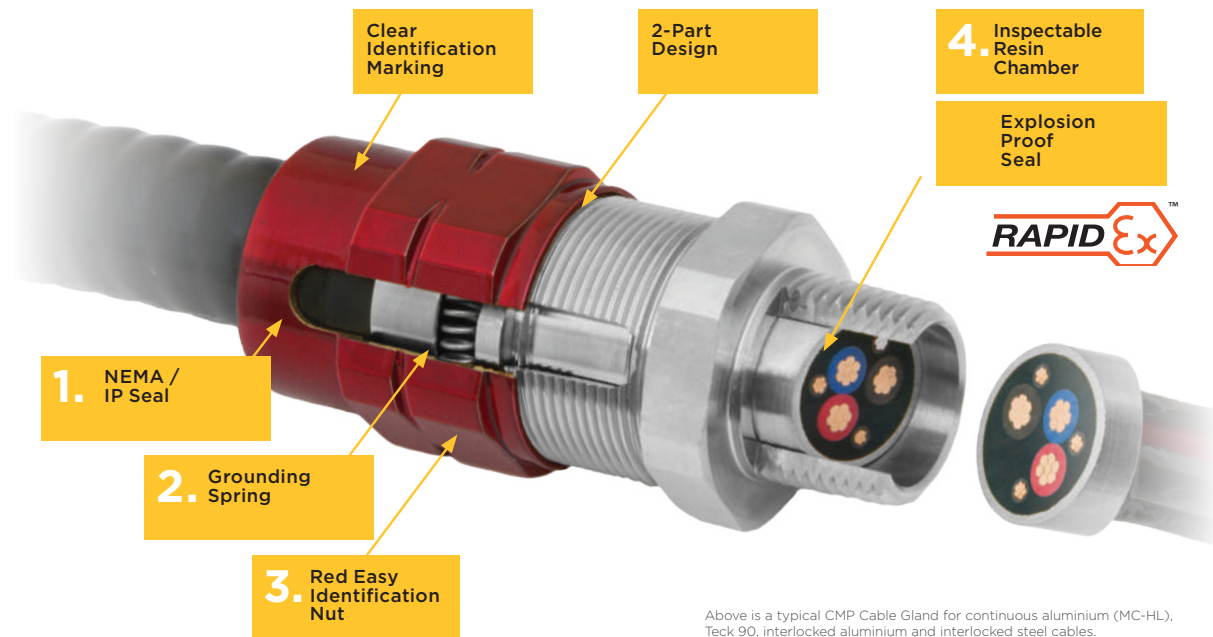

Above is a typical CMP Cable Gland for continuous aluminium (MC-HL), Teck 90, interlocked aluminium and interlocked steel cables.

1.

NEMA / IP ENVIRONMENTAL SEAL

The TMC2X incorporates a 'weak back' seal which is designed to prevent the ingress of dust and rain, splashing water, hose-directed water and damage from exterior ice formation. The seal enables the gland to meet the requirements of NEMA 4X and IP66. The seal provides a wide cable acceptance range allowing cables from 0.5" to 4.25" to be incorporated in only 12 trade sizes of connector. The seal is manufactured from low smoke, flame resistant, halogen-free elastomer which meets the requirements of EN50267-2-1 and LUL Fire Safety Regulations.

2.

ARMOR TERMINATION

The TMC2X has been designed and tested to terminate all types of metal clad cables including continuous aluminium (MC-HL), Teck 90, interlocked aluminium and interlocked steel. An internal corrosion resistant stainless steel spring provides 360° grounding of the armor and allows for easy installation and disconnection of the cable where required. The spring provides excellent pull-out resistance which exceeds the requirements of CSA C22.2 & UL514B. The spring is non-magnetic and is suitable for use with single conductor power cables carrying in excess of 200A.

3.

EASY IDENTIFICATION NUT

Outer seal nuts provided by CMP have large wrench holds for ease of installation and display clear laser marking showing the Cable Gland properties, certification and hazardous location details.

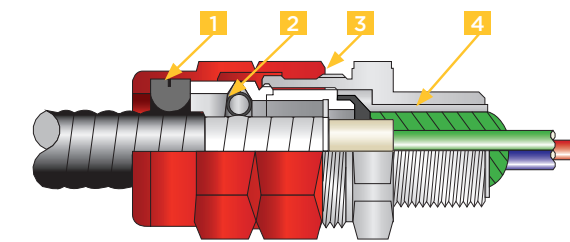

4.

INSPECTABLE RAPIDEX RESIN CHAMBER

A barrier type cable gland which is disconnectable utilizing a tried and tested metal barrier tube which provides an explosion proof joint that enables cables to be safely and easily removed from equipment. The explosion proof joint path can be visually inspected and also measured according to the parameters of IECEx and cCSAus for flame paths.

EXPLOSION PROOF SEAL

The TMC2X incorporates the RapidEx liquid pour, fast curing, liquid resin seal that installs in seconds and cures in minutes. Its unique formula begins with a low viscosity liquid that flows into the cable interstices completely surrounding the cable conductors, driving out all the air in the process. The viscosity then increases and completely cures in minutes. Once cured the RapidEx resin adheres to both the cable conductors and the inside of the barrier tube creating a bond that will last for the life of the cable connector. The RapidEx seal will never crack or shrink with changes in temperature.

TYPICAL CMP DOUBLE SEAL CABLE GLAND

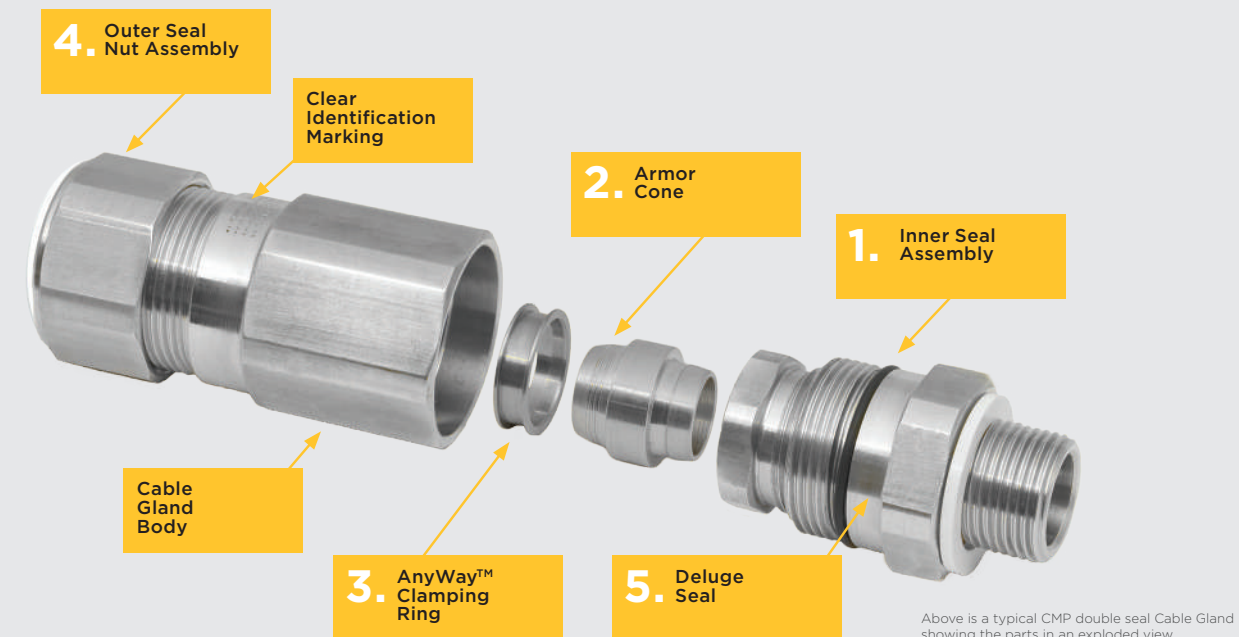

Above is a typical CMP double seal Cable Gland showing the parts in an exploded view.

1.

UNIQUE INDEPENDENT INNER SEALING

The CMP inner sealing principal is quite different from other cable gland types and because the activation of the inner sealing ring is separated from the armor clamping components this means that the possibility of inadvertent over-tightening is eliminated. Unlike traditional compression seals that have no means of direct control on their application, the CMP inner sealing technique is achieved using a displacement seal that is independently controlled by the user during installation.

The Compensating Displacement Seal System (1) has helped CMP to take its original displacement sealing ring concept to another level. The unique Compensator has allowed the Cable Gland components to be fully tightened metal-to-metal and relieve the potential excess forces that could be transferred to the cable bedding, eliminating cable damage and Coldflow characteristics.

2/3.

SECURE ARMOR TERMINATION

CMP Products' armor clamping method involves a unique termination solution that ensures a permanent crimping of the cable armor, creating a low impedance connection that does not suffer from self-loosening. The patented AnyWay™ clamping ring aids an easy 'Right First Time' installation. Secure armor clamping like this also contributes to enhanced levels of EMC performance as well as reliable ground continuity.

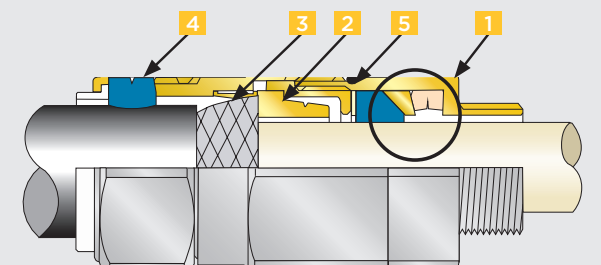

4.

OUTER SEAL

The unique CMP Products Outer Seal Tightening Guide (OSTG) and Load Retention Sealing Ring (LRS) ensure an IP/NEMA rated seal is formed against the cable to the correct degree. This is also applicable to our sealing rings on unarmored Cable Glands.

5.

PROVEN INTERNALLY ENCLOSED DELUGE SEAL

CMP Products integrated 'O' ring deluge seal (tested to DTS 01:91) prevents corrosion of the cable armor by ensuring that moisture cannot track around the Cable Gland threads and into the armor termination body. As an internally enclosed deluge seal the 'O' ring is protected from mechanical damage and harmful UV rays.

HOW TO ORDER

On each of the main Cable Gland product pages in this catalog you will find a Cable Gland selection table which includes the part number for ordering purposes. The part number is composed of the CMP size, type number, and standard suffix.

The default material is nickel plated brass and the thread type is NPT. The basic part number would reflect this unless one or more suffixes are added to the part number, changing the material or the thread type and size, as demonstrated below.

'Standard' cable gland with 'global' certification marking does not include TC RU (Russia, Kazakhstan) or INMETRO (Brazilian) certification details.

For ordering TC, TMC2 and TMC2X please see opposing page.

For ordering TMC and TMCX please see product pages.

EXAMPLE ORDERING

20	T3CDS	1 RA	5	3	1
Size	Type	Standard Suffix I.D.	Nickel Plated Finish	NPT Entry	1/2"

CABLE GLAND SIZE / TYPE	SUPPLY TYPE	CMP SUFFIX***	MATERIAL	ENTRY THREAD TYPE	ENTRY THREAD SIZE**					
					METRIC (FOR REFERENCE ONLY)	NPT / BSP / NPSM	IMPERIAL	PG		
e.g. 20T3CDS	1	RA	Standard Cable Gland	0 or *	Brass	*	Metric	3/8"	1/2"	7
e.g. 40PX2KX		EX	RapidEx Pack	1	Aluminum	1	Imperial Electrical Thread (E.I.)	1/2"	5/8"	9
e.g. 50SC2KX		RA/B	Brazilian Certified Cable Gland	2	Nylon	2	PG	3/4"	3/4"	11
		RU	TC RU Certified Cable Gland	3	Mild Steel	3	NPT	1"	1"	13.5
				4	Stainless Steel	4	BSPP	1 1/4"	1 1/4"	16
				5	Nickel Plated Brass	5	NPSM	1 1/2"	1 1/2"	21
				6		6	BSPT	2"	2"	29
						7		2 1/2"	2 1/2"	36
						8		3"	3"	42
						9		3 1/2"	3 1/2"	48
						10		4"	4"	
						11		5"	5"	
						12				

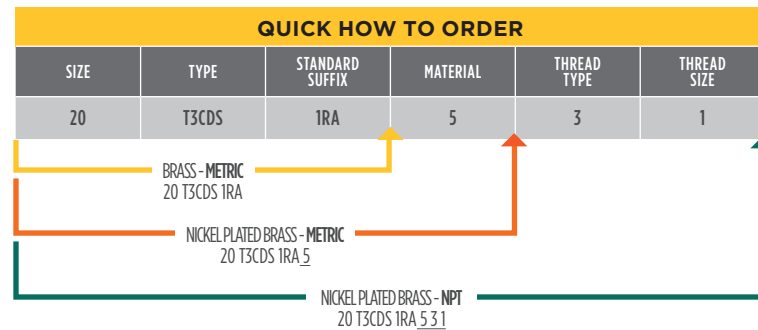

* No suffix required when brass metric cable glands are ordered. Digit 0 to be used for material code only when the threads type is not metric.
 ** Other thread sizes available upon request.
 ***Standard cable gland with 'global' certification marking does not include TC RU (Russia, Kazakhstan) or INMETRO (Brazilian) certification details.



EXAMPLE ORDERING

TC-	100	A	079	No further reference required
Type	1"	Aluminum	0.79"	
TMC2X-	050	NB	099	X No further reference required
Type	1/2"	Nickel Plated Finish	0.99"	Complete kit with RapidEx
TMC2-	075	SS	075	No further reference required
Type	3/4"	Stainless Steel	0.75"	

CABLE GLAND TYPE	THREAD ORDER REFERENCE*	MATERIAL	MAX CABLE JACKET DIAMETER (TMC2, TMC2X)	MAX CABLE DIAMETER (TC)	SUPPLY TYPE
TMC2X	050	A Aluminum	075 0.75"	028 0.28"	X with RapidEx** (TMC2X only)
TMC2	075	SS Stainless Steel	099 0.99"	055 0.55"	
TC	100	NB Nickel Plated Brass	118 1.18"	079 0.79"	
	125		137 1.37"	104 1.04"	
	150		162 1.62"	127 1.27"	
	200		190 1.90"	150 1.50"	
	250		200 2.00"	174 1.74"	
	300		233 2.33"	197 1.97"	
	350		272 2.72"	220 2.20"	
	400		325 3.25"	244 2.44"	
			376 3.76"	268 2.68"	
			425 4.25"	315 3.15"	
				354 3.54"	

* Other thread types and sizes available upon request.
 ** Supplied in pack with RapidEx resin

CMP PRODUCT MARKING

The below shows an example of the product marking for a standard Triton CDS (T3CDS) NPT cable gland. This marking is etched onto the body of the gland, identifying the properties and certification detail. The first page shows the first two lines of the product certification according to IEC, the second page shows the product certification according to NEC and CEC.



LINE 1 - ATEX

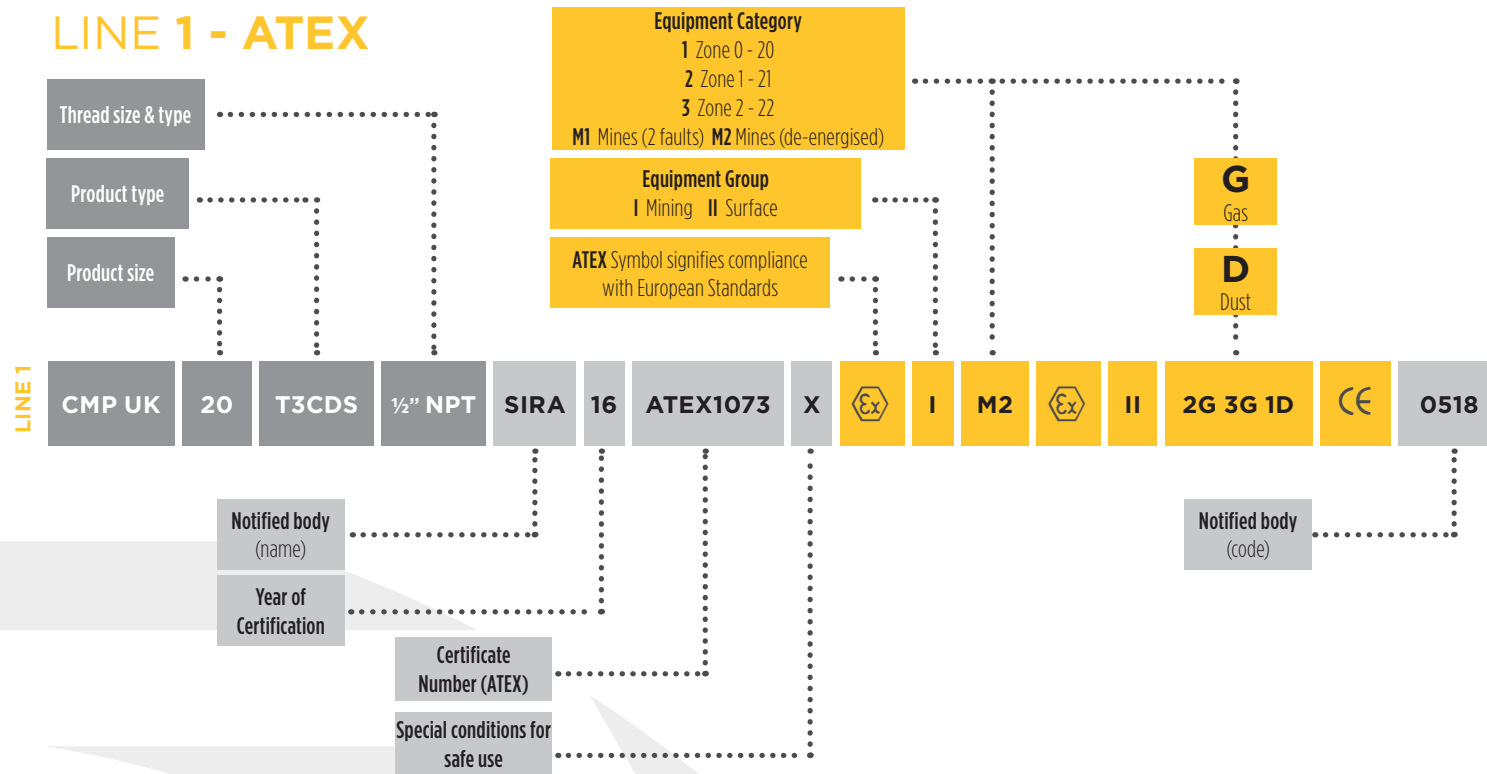

LINE 2 - IECEx

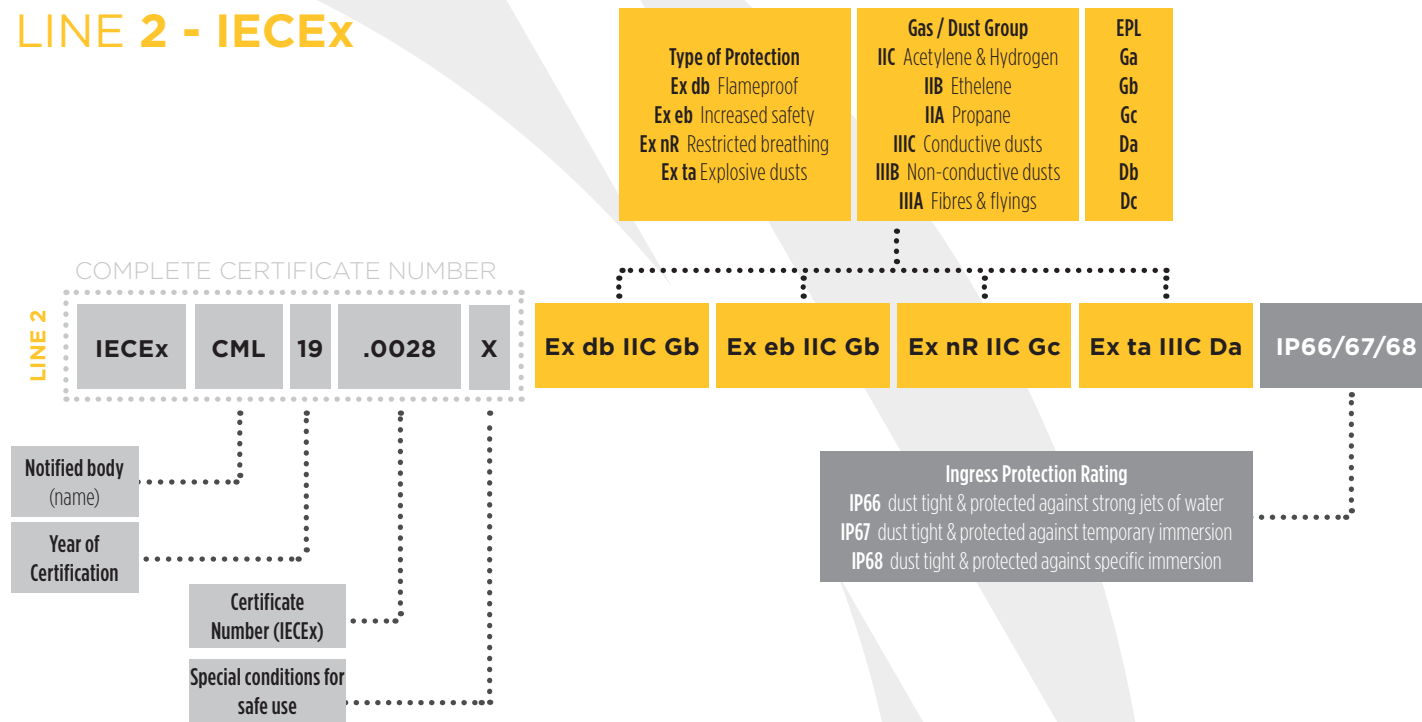

LINE 3 - UL

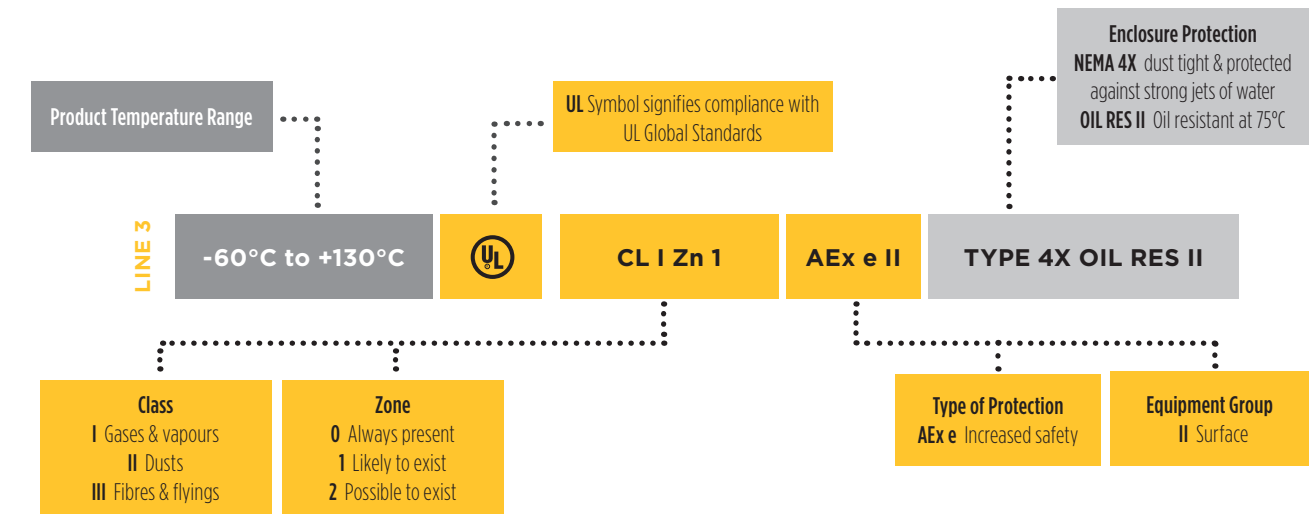

LINE 4 - cCSAus

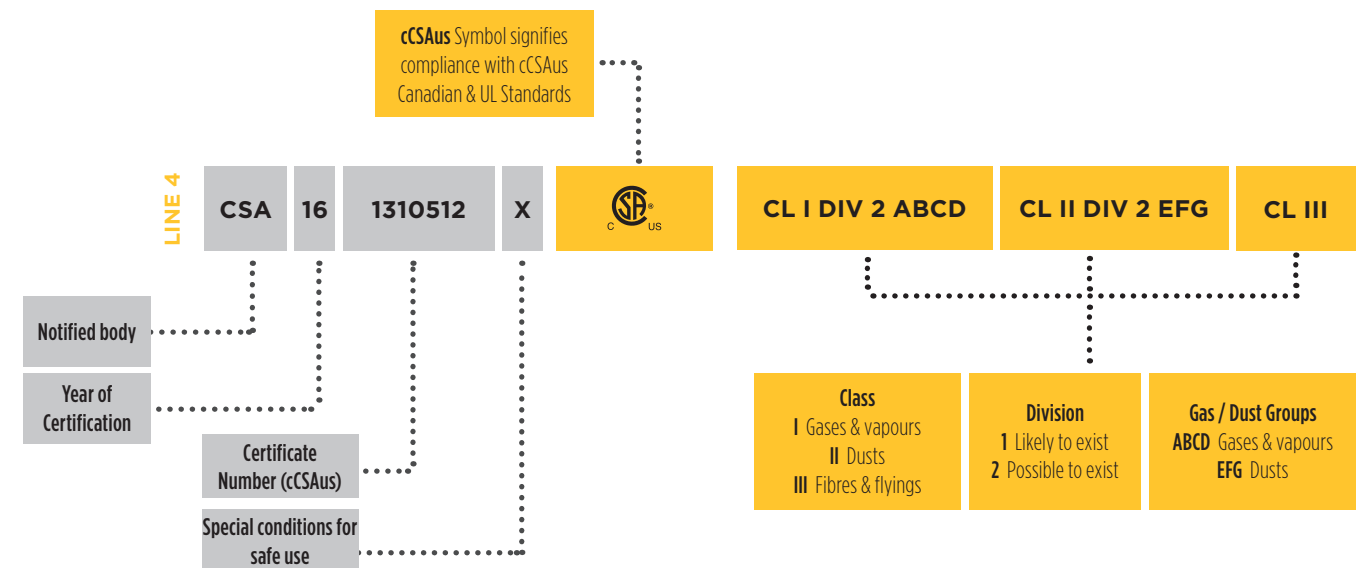

Actual cable gland marking may show slight variations

RAPIDEX THE FAST CURING, GAS BLOCKING, LIQUID RESIN SEAL



THE EFFECTIVE SEALING OF INSTRUMENT AND ELECTRICAL CABLES SHOULD NOT BE UNDERESTIMATED.

Traditional barrier type Cable Glands employing an epoxy-cured clay based sealing compound, have been used in the industry for many years, to provide effective explosion protection. However, a certain degree of skill is required with this traditional installation process and the risk of voids increases with the number of cable cores.

Multi-core cable requires the highest degree of competence and a long installation time to ensure a void-free, safe installation. An inability to recognize this will lead to rework, or risk of failure of the seal.

RapidEx is a liquid pour, fast curing, liquid resin barrier seal that installs in seconds and cures in minutes.

Its unique formula begins with a low viscosity liquid that flows into the cable interstices completely surrounding the cable conductors, and in the process displacing the air from the Cable Gland's sealing chamber ensuring the 'perfect seal'.

- The viscosity increases and completely cures in less than 40 minutes (at 68°F)
- Enhances reliability, reduces risk
- Delivers unprecedented reliability
- Minimizes installation time
- Clean and easy to use

CMP RapidEx is certified for use in hazardous locations with Global Certification including approval under NEC, CEC and IEC installation codes, and is supplied with a series of CMP barrier type cable glands and unions.

MIX



APPLY



SEAL



		CABLE GLAND SIZE (PX** LINE 1, TMC2X LINE 2)															
		205	20 / 20L	25	25S	32	40	50S	50	63S	63	75S	75	90	100		
		075	099	118		137	162	190	200	233			272	325	376	425	
THREAD SIZE	M20	1 X 30	1 X 30														
	M25			1 X 30	1 X 30												
	M32					1 X 30											
	M40						1 X 30										
	M50							1 X 80	1 X 80								
	M63									1 X 80	1 X 80						
	M75											2 X 80	2 X 80				
	M90													2 X 80			
	M100														3 X 80		
	1/2"	1 X 30	1 X 30														
	3/8"	1 X 30	1 X 30	1 X 30													
	1"			1 X 30	1 X 30	1 X 30	1 X 30										
	1 1/4"				1 X 30	1 X 30	1 X 30	1 X 30									
	1 1/2"					1 X 30	1 X 30	1 X 30	1 X 30								
	2"						1 X 80	1 X 80	1 X 80	1 X 80			1 X 80				
	2 1/2"							2 X 80	2 X 80	2 X 80	2 X 80			2 X 80			
3"												3 X 80	3 X 80	3 X 80			
3 1/2"													3 X 80	3 X 80			
4"														3 X 80	3 X 80		

Above table shows which RapidEx resin is required with which CMP Cable Glands

TYPICAL INSTALLATIONS

The illustrations provided below are indicative of some of the common methods of installation configurations adopted. These are for informative guidance only and relevant site conditions and Engineering Specification along with any specified National or International Codes of Practice must always take precedence.

PARALLEL THREADED CABLE GLAND THROUGH CLEARANCE HOLE

Earth continuity may be achieved via **Earth Tag when specified**
 Locknut (3.2 mm),
 Sealing Washer (2.0 mm),
 16 Gauge Stainless Steel Enclosure Wall (1.6 mm) - **Total 6.8 mm**
 Cable Gland Thread Length = 10.0 mm

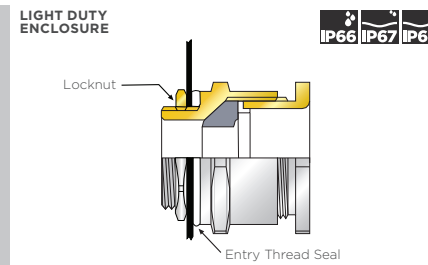

PARALLEL THREADED CABLE GLAND INTO THREADED ENCLOSURE

Earth continuity may be achieved via **threaded entry or Earth Tag when specified**
 Sealing Washer (2.0 mm),
 Enclosure Wall (6.0 mm) - **Total 8.0 mm**
 Cable Gland Thread Length = 10.0 mm

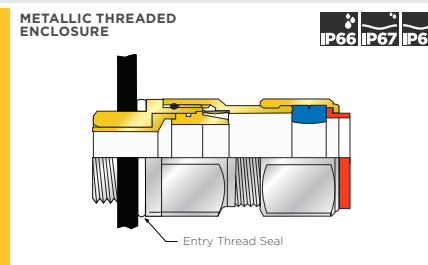

TAPER THREADED CABLE GLAND THROUGH CLEARANCE HOLE

Earth continuity may be achieved via **Earth Tag when specified**
 Locknut (4.75 mm),
 Serrated Washer (3.7 mm),
 Sealing Washer (2.0 mm),
 Earth Tag (1.5 mm),
 10 Gauge Galvanised Steel Enclosure Wall (3.5 mm) - **Total 15.45 mm**
 Cable Gland Thread Length = 19.9 mm

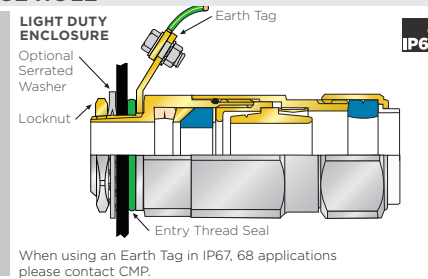

TAPER THREADED CABLE GLAND INTO THREADED ENCLOSURE

Earth continuity achieved via **threaded entry**
Note that care needs to be taken to ensure that the cables are protected as they pass into the enclosure when the wall section is greater than the Cable Gland thread length

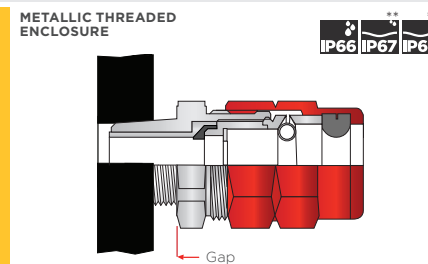

TAPERED X TAPERED ADAPTOR INTO THREADED ENCLOSURE

Earth continuity may be achieved via **threaded entry or Earth Tag when specified**

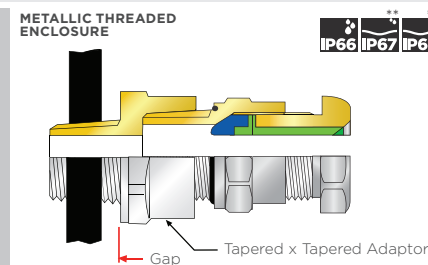

PARALLEL X PARALLEL ADAPTOR THROUGH CLEARANCE HOLE

Earth continuity may be achieved via **Earth Tag when specified**
 Locknut (3.2 mm),
 Serrated Washer (3.3 mm),
 Sealing Washer (2.0 mm),
 16 Gauge Stainless Steel Enclosure Wall (1.6 mm) - **Total 10.1 mm**
 Cable Gland Thread Length = 15.0 mm

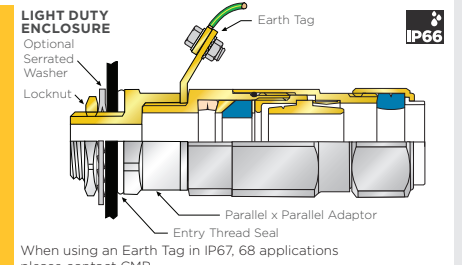

TAPER THREADED CABLE GLAND THROUGH CLEARANCE HOLE

Earth continuity achieved by **Grounding Locknut**
 IP66 achieved by integrated 'o' ring face seal
 Grounding Locknut (12.3 mm),
 10 Gauge Galvanised Steel Enclosure Wall (3.5 mm) - **Total 15.8 mm**
 NPT Cable Gland Thread Length = 19.9 mm

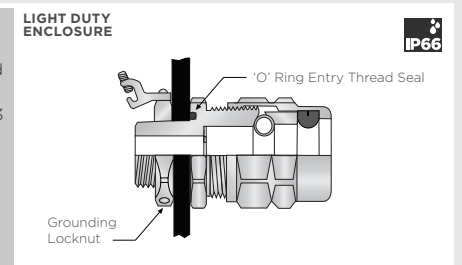

PARALLEL X PARALLEL ADAPTOR INTO THREADED ENCLOSURE

Earth continuity achieved via **threaded entry or Earth Tag when specified**
 Sealing Washer (2.0 mm),
 Enclosure Wall (10.0 mm) - **Total 12.0 mm**
 Cable Gland Thread Length = 15.0 mm

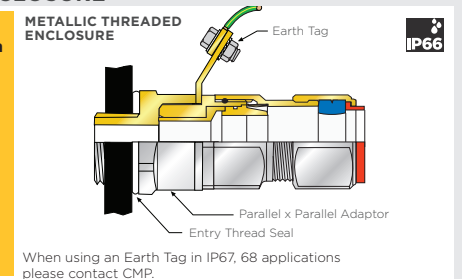

PARALLEL X TAPERED ADAPTOR THROUGH CLEARANCE HOLE

Earth continuity may be achieved via **Earth Tag when specified**
 Locknut (3.2 mm),
 Serrated Washer (3.3 mm),
 Sealing Washer (2.0 mm),
 Earth Tag (1.5 mm),
 10 Gauge Galvanised Steel Enclosure Wall (3.5 mm) - **Total 13.5 mm**
 Cable Gland Thread Length = 15.0 mm

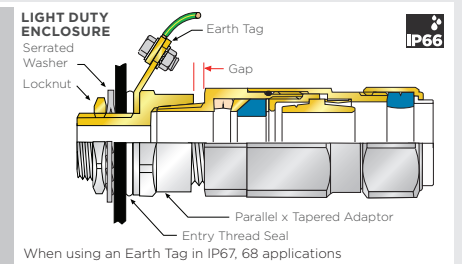

PARALLEL X TAPERED ADAPTOR INTO THREADED ENCLOSURE

Earth continuity may be achieved via **threaded entry or Earth Tag when specified**
 Sealing Washer (2.0 mm),
 Earth Tag (1.5 mm),
 Enclosure Wall (7.5 mm) - **Total 11.0 mm**
 Cable Gland Thread Length = 15.0 mm

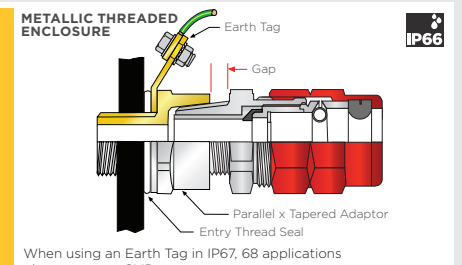

* IP67, IP68 Rating with deluge seal ** IP67, IP68 Rating with deluge seal and appropriate thread grease on tapered threads.

CMP NPT threads do not require additional sealing for IP66 since a male CMP NPT thread fitted to an enclosure / equipment with a female NPT entry thread will maintain equipment Ingress Protection ratings of IP66 without additional sealing (1), provided CMP Installation Fitting Instructions are followed and the threads are 'wrench tight'.

(1) The mating female thread must be machined with the full female thread depth, in compliance with the dimensions and tolerances detailed in the NPT Thread Standard ANSI / ASME B1.20.1:2013. It should be noted that all female NPT threads of any product supplied by CMP are machined in full compliance with this Standard.

TMC

TMC GLOBALLY APPROVED, HAZARDOUS (CLASSIFIED) LOCATION CABLE GLAND

FOR MC, MC-HL, INTERLOCKED & TECK ARMORED CABLES

- Simple, sequential installation process
- No disassembly required
- Integral protected deluge seal
- Low Impedance Copper Plated Stainless Steel 360° Grounding Spring
- -60°C to +130°C (-76°F to +266°F)
- Globally marked, UL, cCSAus, IECEX, ATEX and UKEX
- O-ring face seal supplied with Aluminum glands
- SOLO LSF Halogen Free Shrouds also available on request



TECHNICAL CLASSIFICATION	
DESIGN SPECIFICATION	BS 6121:Part 1:1989, IEC 62444, EN 62444
MECHANICAL CLASSIFICATION*	Impact = Level 8, Cable Anchorage = Type D
ENCLOSURE PROTECTION	IK10 to IEC 62262 (20 joules) Brass and Stainless Steel only
INGRESS PROTECTION RATING**	IP66
NEMA RATING**	Type 4X
CABLE GLAND MATERIAL	Copper Free Aluminum (<0.4%), Electroless Nickel Plated Brass, Stainless Steel
SEAL MATERIAL	CMP SOLO LSF Halogen Free Thermoset Elastomer
CABLE TYPE	Corrugated & Interlocked Metal Clad Armor (MC) or TECK90, Continuously Welded Metal Clad Armor (MC-HL), ACIC-HL, ACWU90-HL, RC90-HL, RA90-HL
ARMOR CLAMPING	Low Impedance Copper Plated Stainless Steel 360° Grounding Spring
SEALING TECHNIQUE	CMP Load Retention Seal
SEALING AREA(S)	Cable Outer Jacket

GLOBAL PRODUCT CERTIFICATION			
ATEX CERTIFICATE	CML18ATEX1337X	IECEX CERTIFICATE	IECEX CML 18.0184X
UKEX CERTIFICATE	CML 21UKEX1261X		
CODE OF PROTECTION	Ⓜ II 2G 1D, Ex eb II Gb, Ex ta IIIC Da	CODE OF PROTECTION	Ex eb II Gb, Ex ta IIIC Da
COMPLIANCE STANDARDS	EN 60079-0,7,31	COMPLIANCE STANDARDS	IEC 60079-0,7,31
cCSAus CERTIFICATE	1129339		
CSAus CODE OF PROTECTION	Class II, Div 1 and 2, Groups E, F, and G; Class III, Div 1 and 2; Encl. Types 3, 4, and 4X; Ex e II; Class I, Zone 1, AEx e II		
cCSA CODE OF PROTECTION	Class II, Div 1 and 2, Groups E, F, and G; Class III, Div 1 and 2; Encl. Types 3, 4, and 4X; Ex e II		
COMPLIANCE STANDARDS	CAN/CSA-C22.2 No 0-10,18.3-04,25-1966,174-M1984,94-M91, CAN/CSA-C22.2 No.60079-0, CAN/CSA-E60079-7:07, ANSI/UL 514B, ANSI/UL 50, ANSI/UL 60079-0,7		
UL CERTIFICATE	E256366		
CODE OF PROTECTION	Class I, Zone 1, AEx e II; Class I, Zone 2, AEx e II		
COMPLIANCE STANDARDS	UL 514B, UL 60079-0,7, UL 2225		
ECAS CERTIFICATE	20-02-05628	UKrSEPRO CERTIFICATE	CLQ 19.0371X
CCOE / PESO (INDIA) CERTIFICATE	P533772		
CCC CERTIFICATE	2020322313003429		
MARINE APPROVALS	LRS: LR22320739TA, DNV: TAE000000V, ABS: 20-LD1948801-PDA, BV: 43180		

* Mechanical and Electrical Classifications applied as per IEC 62444 and EN 62444
 ** When CMP installation accessories are used. Refer to www.cmp-products.com for further information.

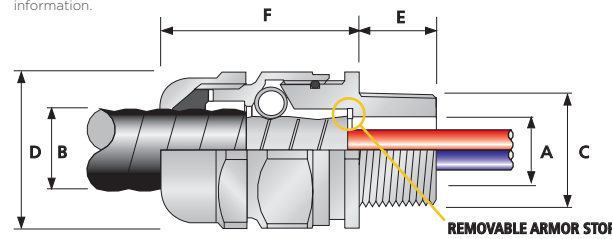

Please note the following installation requirements: 1) Where Explosionproof enclosures are being used the TMC must be installed with an approved pouring or compound sealing fitting. In Division 2 locations the TMC can be fitted directly to an enclosure which has no source of ignition in accordance with NEC/CEC requirements. 2) Glands with NPT entry threads are suitable for both Divisions and Zones. 3) Glands with Metric entry threads are suitable for Zones only unless fitted with an approved NPT male adaptor in accordance with CEC requirements.

ORDER REFERENCE (NPT)			ENTRY THREAD 'C'		MINIMUM THREAD LENGTH 'E'		CABLE ARMOR DIAMETER 'A'				CABLE JACKET DIAMETER 'B'		MAX		SHROUD	WEIGHT (oz)	
ALUMINUM	NICKEL PLATED BRASS	STAINLESS STEEL	NPT	METRIC	NPT	METRIC	END STOP IN		END STOP OUT		MIN	MAX	NOMINAL ASSEMBLY LENGTH 'F'	ACROSS FLATS 'D'			ACROSS CORNERS 'D'
							MIN	MAX	MIN	MAX							
TMC050SA	TMC050SNB	TMC050SSS	½"	M20	0.78	0.59	No Stop	No Stop	0.34	0.50	0.35	0.55	1.83	1.20	1.32	PVC06	7.90
TMC050A	TMC050NB	TMC050SS	½"	M20	0.78	0.59	No Stop	No Stop	0.51	0.67	0.55	0.79	2.06	1.42	1.56	PVC09	9.91
TMC075A	TMC075NB	TMC075SS	¾"	M25	0.80	0.59	0.59	0.76	0.76	0.92	0.67	1.04	2.09	1.61	1.78	PVC10	11.61
TMC100A	TMC100NB	TMC100SS	1"	M32	0.98	0.59	0.78	0.97	1.15	0.91	1.27	2.24	1.97	2.17	PVC13	17.53	
TMC125A	TMC125NB	TMC125SS	1 ¼"	M40	1.01	0.59	1.08	1.23	1.39	1.16	1.50	2.22	2.17	2.38	PVC15	20.92	
TMC150A	TMC150NB	TMC150SS	1 ½"	M50	1.03	0.59	1.32	1.46	1.62	1.40	1.74	2.31	2.36	2.60	PVC18	24.45	
TMC200SA	TMC200SNB	TMC200SSS	2"	M50	1.06	0.59	1.51	1.68	1.85	1.58	1.97	2.52	2.76	3.03	PVC21	42.33	
TMC200A	TMC200NB	TMC200SS	2"	M63	1.06	0.59	1.77	1.93	2.09	1.86	2.21	2.49	2.95	3.25	PVC23	38.80	
TMC250SA	TMC250SNB	TMC250SSS	2 ½"	M75	1.57	0.59	2.05	2.16	2.32	2.08	2.44	2.73	3.15	3.47	PVC25	59.97	
TMC250A	TMC250NB	TMC250SS	2 ½"	M75	1.57	0.59	2.25	2.41	2.41	2.41	2.55	2.33	2.68	3.35	3.68	PVC27	56.48
TMC300A	TMC300NB	TMC300SS	3"	M90	1.63	0.59	2.54	2.78	2.97	2.62	3.13	3.87	4.33	4.76	LSF32	123.46	
TMC350A	TMC350NB	TMC350SS	3 ½"	M100	1.69	0.95	2.91	3.29	3.49	2.99	3.83	4.63	5.25	5.78	LSF34	236.34	

Order code example: TMC250SS "TMC" (Gland Type) - "250" (2 ½" NPT Thread) - "SS" (Material Stainless Steel)
 Dimensions are displayed in inches unless otherwise stated
 For 4" TMC cable glands please contact CMP

TMCX

TMCX GLOBALLY APPROVED, HAZARDOUS (CLASSIFIED) LOCATION BARRIER CABLE GLAND

FOR MC, MC-HL, INTERLOCKED & TECK ARMORED CABLES

- Simple, sequential installation process
- Compound barrier type flameproof seal
- Integral protected deluge seal
- Low Impedance Copper Plated Stainless Steel 360° Grounding Spring
- Disconnectable, union design feature
- -60°C to +85°C (-76°F to +185°F)
- Globally marked, UL, cCSAus, IECEX, ATEX and UKEX

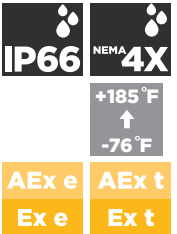

TECHNICAL CLASSIFICATION	
DESIGN SPECIFICATION	BS 6121:Part 1:1989, IEC 62444, EN 62444
MECHANICAL CLASSIFICATION*	Impact = Level 8, Cable Anchorage = Type D
ENCLOSURE PROTECTION	IK10 to IEC 62262 (20 joules) Brass and Stainless Steel only
INGRESS PROTECTION RATING**	IP66
NEMA RATING**	Type 4X
CABLE GLAND MATERIAL	Copper Free (<0.4%) Aluminum, Stainless Steel, Electroless Nickel Plated Brass
SEAL MATERIAL	CMP SOLO LSF Halogen Free Thermoset Elastomer / Epoxy Barrier Compound
CABLE TYPE	Corrugated and Interlocked Metal Clad Armor (MC) or TECK90, Continuously Welded Metal Clad Armor (MC-HL), ACIC-HL, ACWU90-HL, RC90-HL, RA90-HL
ARMOR CLAMPING	Low Impedance Copper Plated Stainless Steel 360° Grounding Spring
JACKET SEALING TECHNIQUE	CMP Displacement Seal
SEALING AREA(S)	Inner Compound Barrier and Cable Outer Jacket

* Mechanical and Electrical Classifications applied as per IEC 62444 and EN 62444
 ** When CMP installation accessories are used. Refer to www.cmp-products.com for further information.

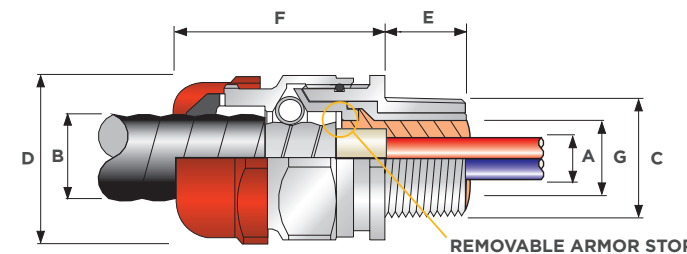

GLOBAL PRODUCT CERTIFICATION			
ATEX CERTIFICATE	CML18ATEX1337X	IECEX CERTIFICATE	IECEX CML 18.0184X
UKEX CERTIFICATE	CML 21UKEX1261X		
CODE OF PROTECTION	Ⓜ II 2G 1D, Ex db IIC, Ex eb IIC, Ex ta IIIC Da	CODE OF PROTECTION	Ex db IIC, Ex eb II, Ex ta IIIC Da
COMPLIANCE STANDARDS	EN 60079-0,1,7,31	COMPLIANCE STANDARDS	IEC 60079-0,1,7,31
cCSAus CERTIFICATE	1129339		
CSAus CODE OF PROTECTION	Class I, Div 1 and 2, Groups A, B, C, and D; Class II, Div 1 and 2, Groups E, F, and G; Class III, Div 1 and 2; Encl. Types 3, 4, and 4X; Class I, Zone 1, AEx d IIC; AEx e II		
cCSA CODE OF PROTECTION	Class I, Div 1 and 2, Groups A, B, C, and D; Class II, Div 1 and 2, Groups E, F, and G; Class III, Div 1 and 2; Encl. Types 3, 4, and 4X; Ex d IIC; Ex e II		
COMPLIANCE STANDARDS	CAN/CSA-C22.2 No 0-10,18.3-04,25-1966,174-M1984,94-M91, CAN/CSA-C22.2 No.60079-0,1; ANSI/UL 514B, ANSI/UL 50, ANSI/UL 60079-0,1,7, CAN/CSA-E60079-7:07		
UL CERTIFICATE	E161256, E256366		
CODE OF PROTECTION	Class I, Div 1 and 2, Groups A, B, C, and D; Class II, Div 1 and 2, Groups E, F, and G; Class III, Div 1 and 2; Class I, Zone 1, AEx d IIC		
COMPLIANCE STANDARDS	UL 514B, UL 2225, IEC 60529		
ECAS CERTIFICATE	20-02-05628	UKrSEPRO CERTIFICATE	CLQ 19.0371X
RETIE APPROVAL NUMBER	03866	CCOE / PESO (INDIA) CERTIFICATE	P548696, P533772
CCC CERTIFICATE	2020322313003429		
MARINE APPROVALS	LRS: LR22320739TA, DNV: TAE000000V, ABS: 20-LD1948801-PDA, BV: 43180		



ORDER REFERENCE (NPT)			ENTRY THREAD 'C'		MINIMUM THREAD LENGTH 'E'		CABLE ARMOR DIAMETER 'A'				CABLE JACKET DIAMETER 'B'		NOMINAL ASSEMBLY LENGTH 'F'	MAX		SHROUD	WEIGHT (oz)
ALUMINUM	NICKEL PLATED BRASS	STAINLESS STEEL	NPT	METRIC	NPT	METRIC	ARMOR STOP IN		ARMOR STOP OUT		MIN	MAX		ACROSS FLATS 'D'	ACROSS CORNERS 'D'		
							MIN	MAX	MIN	MAX							
TMCX050SA	TMCX050SNB	TMCX050SSS	½"	M20	0.78	0.59	No Stop	No Stop	0.34	0.50	0.35	0.55	1.83	1.20	1.32	PVC06	7.90
TMCX050A	TMCX050NB	TMCX050SS	½"	M20	0.78	0.59	No Stop	No Stop	0.51	0.67	0.55	0.79	2.06	1.42	1.56	PVC09	9.91
TMCX075A	TMCX075NB	TMCX075SS	¾"	M25	0.80	0.59	0.59	0.76	0.92	0.67	1.04	2.09	1.61	1.78	PVC10	11.61	
TMCX100A	TMCX100NB	TMCX100SS	1"	M32	0.98	0.59	0.78	0.97	1.15	0.91	1.27	2.24	1.97	2.17	PVC13	17.53	
TMCX125A	TMCX125NB	TMCX125SS	1 ¼"	M40	1.01	0.59	1.08	1.23	1.39	1.16	1.50	2.22	2.17	2.38	PVC15	20.92	
TMCX150A	TMCX150NB	TMCX150SS	1 ½"	M50	1.03	0.59	1.32	1.46	1.62	1.40	1.74	2.31	2.36	2.60	PVC18	24.45	
TMCX200SA	TMCX200SNB	TMCX200SSS	2"	M50	1.06	0.59	1.51	1.68	1.85	1.58	1.97	2.52	2.76	3.03	PVC21	42.33	
TMCX200A	TMCX200NB	TMCX200SS	2"	M63	1.06	0.59	1.77	1.93	2.09	1.86	2.21	2.49	2.95	3.25	PVC23	38.80	
TMCX250SA	TMCX250SNB	TMCX250SSS	2 ½"	M75	1.57	0.59	2.05	2.16	2.32	2.08	2.44	2.73	3.15	3.47	PVC25	59.97	
TMCX250A	TMCX250NB	TMCX250SS	2 ½"	M75	1.57	0.59	2.25	2.41	2.41	2.41	2.55	2.33	2.68	3.35	3.68	PVC27	56.48
TMCX300A	TMCX300NB	TMCX300SS	3"	M90	1.63	0.95	2.54	2.78	2.97	2.62	3.13	3.87	4.33	4.76	LSF32	123.46	
TMCX350A	TMCX350NB	TMCX350SS	3 ½"	M100	1.69	0.95	2.91	3.29	3.49	2.99	3.83	4.52	5.25	5.78	LSF34	236.34	

Order code example: TMCX250SS "TMCX" (Gland Type) - "250" (2 ½" NPT Thread) - "SS" (Material Stainless Steel)
 Dimensions are displayed in inches unless otherwise stated
 For 4" TMCX cable glands please contact CMP

TMC2

TMC2 ALUMINUM GLOBALLY APPROVED, HAZARDOUS (CLASSIFIED) LOCATION CABLE GLAND

FOR MC, MC-HL, INTERLOCKED & TECK ARMORED CABLES

- Simplified two part design
- Compact slim profile
- Independent sealing and armor clamping
- Simple, sequential installation process
- No disassembly required
- O-ring face seal as standard
- Hub not required
- Low Impedance Copper Plated Stainless Steel 360° Grounding Spring
- -60°C to +110°C (-76°F to +230°F)
- Globally marked, cCSAus, IECEx, ATEX and UKEX

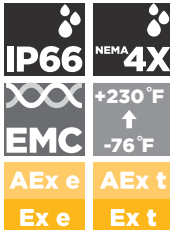
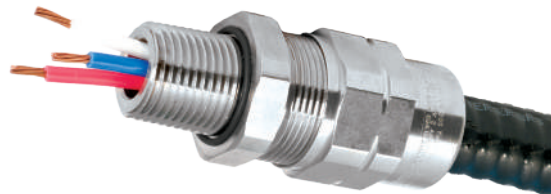

TECHNICAL CLASSIFICATION	
DESIGN SPECIFICATION	BS 6121:Part 1:1989, IEC 62444, EN 62444
MECHANICAL CLASSIFICATION*	Impact = Level 8, Cable Anchorage = Type D
ENCLOSURE PROTECTION	IK10 to IEC 62262 (20 joules) Brass and Stainless Steel only
INGRESS PROTECTION RATING**	IP66
NEMA RATING**	Type 4X
CABLE GLAND MATERIAL	Copper Free (<0.4%) Aluminum, Stainless Steel, Electroless Nickel Plated Brass
SEAL MATERIAL	CMP SOLO LSF Halogen Free Thermoset Elastomer
CABLE TYPE	Corrugated & Interlocked Metal Clad Armor (MC) or TECK90, Continuously Welded Metal Clad Armor (MC-HL), ACIC-HL, ACWU90-HL, RC90-HL, RA90-HL
ARMOR CLAMPING	Low Impedance Copper Plated Stainless Steel 360° Grounding Spring
JACKET SEALING TECHNIQUE	CMP Load Retention Seal
SEALING AREA(S)	Cable Outer Jacket

GLOBAL PRODUCT CERTIFICATION			
ATEX CERTIFICATE	CML18ATEX1335X	IECEX CERTIFICATE	IECEX CML 18.0192X
UKEX CERTIFICATE	CML 21UKEX1262X		
CODE OF PROTECTION	II 2G 1D, Ex db IIC Gb, Ex ta IIIC Da	CODE OF PROTECTION	Ex db IIC Gb, Ex ta IIIC Da
COMPLIANCE STANDARDS	EN 60079-0,7	COMPLIANCE STANDARDS	IEC 60079-0,7,31
cCSAus CERTIFICATE	2194053		
CSAus CODE OF PROTECTION	Class II, Div 1 and 2, Groups E, F, and G; Class III, Div 1 and 2; Encl. Type 4X; Ex e II; Class I, Zone 1, AEx e II; AEx ta IIIC		
cCSA CODE OF PROTECTION	Class I, Div 2, Groups A, B, C, and D; Class II, Div 1 and 2, Groups E, F, and G; Class III, Div 1 and 2; Encl. Type 4X; Ex e II; Class I, Zone 1, AEx e II; AEx ta IIIC Class I, Zone 1, AEx e II; AEx ta IIC		
COMPLIANCE STANDARDS	CAN/CSA-C22.2 No 0-10-18-04, 25-1966, 30-M1986, 174-M1984, 94-M91, ANSI/UL 2225, ANSI/UL 50, ANSI/UL 514B, CAN/CSA-E61241-1-1, CAN/CSA-C22.2 No. 60079-0:07:07		
ECAS CERTIFICATE	20-02-06425	ULxSEPRO CERTIFICATE	CL1 19.0371X
RETIÉ APPROVAL NUMBER	03866	CCOE / PESO (INDIA) CERTIFICATE	P533772
CCC CERTIFICATE	2020322313003284		
MARINE APPROVALS	LRS: LR2220739TA, DNV: TAE00000Y, ABS: 20-2022051-PDA, BV: 43180		



* Mechanical and Electrical Classifications applied as per IEC 62444 and EN 62444
 ** When CMP installation accessories are used. Refer to www.cmp-products.com for further information.

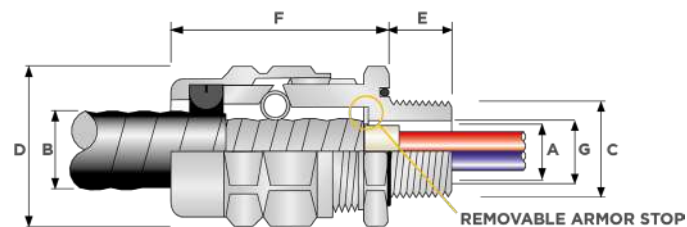

ORDER REFERENCE (NPT SUFFIX REQUIRED)	ENTRY THREAD °C		MINIMUM THREAD LENGTH 'E'	CABLE ARMOR DIAMETER 'A'				CABLE JACKET DIAMETER 'B'	THRU BORE 'G'	ACROSS FLATS 'D'	ACROSS CORNERS 'D'	NOMINAL ASSEMBLY LENGTH 'F'	SHROUD	APPROX WEIGHT ALUMINUM (oz)			
	ALUMINUM	NICKEL PLATED BRASS		STAINLESS STEEL	ARMOR STOP IN		ARMOR STOP OUT										
					MIN	MAX	MIN								MAX		
TMC2050A075	TMC2050NB075	TMC2050SS075	½"	-	0.78	0.42	0.55	0.55	0.63	0.50	0.75	0.51	1.20	1.32	2.44	PVC06	2.29
TMC2075A075	TMC2075NB075	TMC2075SS075	¾"	-	0.80	0.42	0.55	0.55	0.63	0.69	0.99	0.51	1.48	1.63	2.96	PVC09	3.00
TMC2050A099	TMC2050NB099	TMC2050SS099	½"	-	0.78	0.60	0.65	0.65	0.89	0.69	0.99	0.61	1.48	1.63	2.96	PVC09	3.00
TMC2075A099	TMC2075NB099	TMC2075SS099	¾"	-	0.80	0.60	0.78	0.78	0.89	0.69	0.99	0.75	1.48	1.63	2.96	PVC09	3.00
TMC2075A118	TMC2075NB118	TMC2075SS118	¾"	-	0.80	0.79	0.86	0.86	1.10	0.87	1.18	0.82	1.81	1.99	3.15	PVC11	5.11
TMC2100A118	TMC2100NB118	TMC2100SS118	1"	-	0.98	0.79	0.98	0.98	1.10	1.02	1.37	0.95	2.05	2.26	3.55	PVC15	6.70
TMC2100A137	TMC2100NB137	TMC2100SS137	1 ¼"	-	0.98	0.94	1.08	1.08	1.28	1.02	1.37	1.04	2.05	2.26	3.55	PVC15	6.70
TMC2125A137	TMC2125NB137	TMC2125SS137	1 ½"	-	1.01	0.94	1.18	1.18	1.28	1.02	1.37	1.14	2.05	2.26	3.55	PVC15	6.70
TMC2125A162	TMC2125NB162	TMC2125SS162	1 ¾"	-	1.01	1.22	1.35	1.35	1.50	1.30	1.62	1.31	2.36	2.60	3.59	PVC18	8.82
TMC2150A162	TMC2150NB162	TMC2150SS162	1 ¾"	-	1.03	1.22	1.42	1.42	1.50	1.30	1.62	1.38	2.36	2.60	3.59	PVC18	8.82
TMC2125A190	TMC2125NB190	TMC2125SS190	1 ¾"	-	1.01	-	-	1.51	1.72	1.57	1.90	1.37	2.56	2.82	3.59	PVC37	9.45
TMC2150A190	TMC2150NB190	TMC2150SS190	1 ¾"	-	1.03	-	-	1.51	1.72	1.57	1.90	1.54	2.56	2.82	3.59	PVC37	9.45
TMC2150A200	TMC2150NB200	TMC2150SS200	1 ½"	-	1.03	1.57	1.70	1.70	1.88	1.65	2.00	1.61	2.75	3.03	3.76	PVC21	11.06
TMC2200A200	TMC2200NB200	TMC2200SS200	-	2"	1.06	1.57	1.70	1.70	1.88	1.65	2.00	1.65	2.75	3.03	3.76	PVC21	11.06
TMC2150A233	TMC2150NB233	TMC2150SS233	-	1 ½"	1.03	-	-	1.81	2.21	1.61	1.90	1.61	2.95	3.25	-	PVC23	12.77
TMC2200A233	TMC2200NB233	TMC2200SS233	-	2"	1.06	-	-	1.81	2.21	1.90	2.33	2.03	3.54	3.89	-	PVC28	12.77
TMC2250A233	TMC2250NB233	TMC2250SS233	-	2 ½"	1.57	-	-	1.81	2.21	2.03	2.33	2.03	3.54	3.89	-	PVC28	12.77
TMC2200A272	TMC2200NB272	TMC2200SS272	-	2"	1.06	2.14	2.46	2.17	2.61	2.07	2.72	2.40	3.54	3.89	-	PVC28	24.69
TMC2250A272	TMC2250NB272	TMC2250SS272	-	2 ½"	1.57	2.14	2.46	2.46	2.61	2.40	2.72	2.40	4.33	4.76	-	PVC31	24.69
TMC2300A272	TMC2300NB272	TMC2300SS272	-	3"	1.63	2.14	2.46	2.46	2.61	2.40	2.72	2.40	4.33	4.76	-	PVC31	24.69
TMC2300A325	TMC2300NB325	TMC2300SS325	-	3"	1.63	2.49	2.78	2.78	2.97	2.72	2.97	2.72	4.33	4.76	-	PVC31	42.68
TMC2350A325	TMC2350NB325	TMC2350SS325	-	3 ½"	1.69	2.49	2.78	2.78	2.97	2.72	2.97	2.72	4.33	4.76	-	PVC31	42.68
TMC2350A376	TMC2350NB376	TMC2350SS376	-	3 ½"	1.69	2.95	3.45	3.45	3.54	3.16	3.76	3.38	4.84	5.32	4.95	LSF33	53.44
TMC2400A376	TMC2400NB376	TMC2400SS376	-	4"	1.73	2.95	3.45	3.45	3.54	3.16	3.76	3.38	4.84	5.32	4.95	LSF33	53.44
TMC2400A425	TMC2400NB425	TMC2400SS425	-	4"	1.73	-	-	3.56	3.94	3.70	4.25	3.59	5.23	5.75	5.16	LSF34	59.19

Order code example: TMC2050A075 - "TMC2" (Type Gland) - "050" (½" NPT Thread) - "A" (Material Aluminum) - "075" (Max Cable Diameter 0.75")

Dimensions are displayed in inches unless otherwise stated

TMC2X



GLOBALLY APPROVED, HAZARDOUS (CLASSIFIED) LOCATION BARRIER CABLE GLAND

FOR MC, MC-HL, INTERLOCKED & TECK ARMORED CABLES

- RapidEx liquid pour sealing system reduces installation time
- Simplified two part design
- Compact slim profile
- Independent sealing and armor clamping
- Simple, sequential installation process
- Low impedance copper plated stainless steel 360° grounding spring
- Disconnectable, union design feature
- -60°C to +85°C (-76°F to +185°F)
- Globally marked, UL, cCSAus, IECEx, ATEX and UKEX

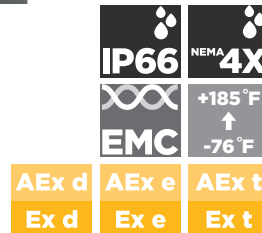

TECHNICAL CLASSIFICATION	
DESIGN SPECIFICATION	BS 6121:Part 1:1989, IEC 62444, EN 62444
MECHANICAL CLASSIFICATION*	Impact = Level 8, Cable Anchorage = Type D
ENCLOSURE PROTECTION	IK10 to IEC 62262 (20 joules) Brass and Stainless Steel only
INGRESS PROTECTION RATING**	IP66
NEMA RATING**	Type 4X
CABLE TYPE	Corrugated & Interlocked Metal Clad Armor (MC) or TECK90, Continuously Welded Metal Clad Armor (MC-HL), ACIC-HL, ACWU90-HL, RC90-HL, RA90-HL
ARMOR CLAMPING	Low Impedance Copper Plated Stainless Steel 360° Grounding Spring
JACKET SEALING TECHNIQUE	CMP Load Retention Seal
SEALING AREA(S)	RapidEx Liquid Resin, Cable Outer Jacket
CABLE GLAND MATERIAL	Copper Free (<0.4%) Aluminum, Stainless Steel, Electroless Nickel Plated Brass

* Mechanical and Electrical Classifications applied as per IEC 62444 and EN 62444
 ** When CMP installation accessories are used. Refer to www.cmp-products.com for further information.

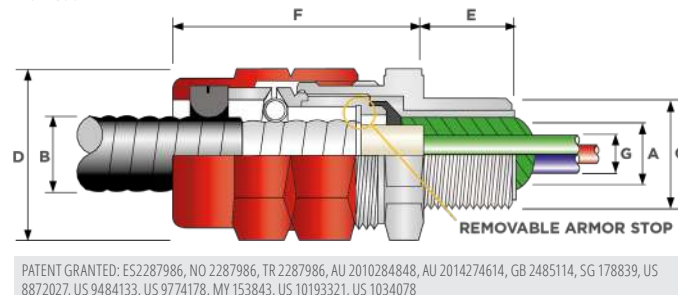

PATENT GRANTED: ES2287986, NO 2287986, TR 2287986, AU 2010284848, AU 2014274614, GB 2485114, SG 178839, US 8872027, US 9484133, US 9774178, MY 153843, US 10193321, US 1034078

GLOBAL PRODUCT CERTIFICATION			
ATEX CERTIFICATE	CML18ATEX1336X	IECEX CERTIFICATE	IECEX CML 18.0193X
UKEX CERTIFICATE	CML 21UKEX1263X		
CODE OF PROTECTION	II 2G 1D, Ex db IIC, Ex eb IIC Gb, Ex ta IIIC Da	CODE OF PROTECTION	Ex db IIC Gb, Ex eb IIC Gb, Ex ta IIIC Da
COMPLIANCE STANDARDS	EN 60079-0,1,7,31	COMPLIANCE STANDARDS	IEC 60079-0,1,7,31
cCSAus CERTIFICATE	2194053		
CSAus CODE OF PROTECTION	Class I, Div 1 and 2, Groups A,B,C, and D; Class II, Div 1 and 2, Groups E, F, and G; Class III, Div 1 and 2; Encl. Type 4X; Ex e II; Class I, Zone 1, AEx d IIC; AEx e II; AEx ta IIIC		
cCSA CODE OF PROTECTION	Class I, Div 1 and 2, Groups A, B, C, and D; Class II, Div 1 and 2, Groups E, F, and G; Class III, Div 1 and 2; Encl. Type 4X; Ex d IIC; Ex e II; Class I, Zone 1, AEx d IIC; AEx e II; AEx ta IIIC		
COMPLIANCE STANDARDS	CAN/CSA-C22.2 No 0-M91,18-04, 25-1966, 30-M1986, 174-M1984, 94-M91, CAN/CSA-60079-0,1,7, CAN/CSA-E61241-1-1, ANSI/UL 514B, ANSI/UL 50, ANSI/UL 2225		
cULus CERTIFICATE (075-162)	E161256		
CODE OF PROTECTION	Class I, Div 1 and 2, Groups A, B, C, and D; Class II, Div 1 and 2, Groups E, F, and G; Class III, Div 1 and 2		
COMPLIANCE STANDARDS	UL2225, UL514B, CSA C22.2 No. 174-18, 18.3-12		
ECAS CERTIFICATE	20-02-06423	ULxSEPRO CERTIFICATE	CL1 19.0371X
RETIÉ APPROVAL NUMBER	03866	CCOE / PESO (INDIA) CERTIFICATE	P548696, P533772
CCC CERTIFICATE	2020322313003283		
MARINE APPROVALS	LRS: LR2220739TA, DNV: TAE00000Y, ABS: 20-2022051-PDA, BV: 43180		



ORDER REFERENCE (NPT WITH RAPIDEX RESIN)	ENTRY THREAD °C		MINIMUM THREAD LENGTH 'E'	CABLE ARMOR DIAMETER 'A'				CABLE JACKET DIAMETER 'B'	THRU BORE 'G'	ACROSS FLATS 'D'	ACROSS CORNERS 'D'	NOMINAL ASSEMBLY LENGTH 'F'	SHROUD	APPROX WEIGHT ALUMINUM (oz)			
	ALUMINUM	NICKEL PLATED BRASS		STAINLESS STEEL	ARMOR STOP IN		ARMOR STOP OUT										
					MIN	MAX	MIN								MAX		
TMC2X-050A075X	TMC2X-050NB075X	TMC2X-050SS075X	½"	-	0.78	0.42	0.55	0.55	0.63	0.500	0.750	0.51	1.20	1.32	2.44	PVC06	2.29
TMC2X-075A075X	TMC2X-075NB075X	TMC2X-075SS075X	¾"	-	0.80	0.42	0.55	0.55	0.63	0.500	0.750	0.51	1.48	1.63	2.96	PVC09	3.00
TMC2X-050A099X	TMC2X-050NB099X	TMC2X-050SS099X	½"	-	0.78	0.60	0.65	0.65	0.89	0.690	0.990	0.51	1.48	1.63	2.96	PVC09	3.00
TMC2X-075A099X	TMC2X-075NB099X	TMC2X-075SS099X	¾"	-	0.80	0.60	0.78	0.78	0.89	0.690	0.990	0.71	1.48	1.63	2.96	PVC09	3.00
TMC2X-075A118X	TMC2X-075NB118X	TMC2X-075SS118X	¾"	-	0.80	0.79	0.86	0.86	1.10	0.870	1.180	0.71	1.81	1.99	3.15	PVC11	5.11
TMC2X-100A118X	TMC2X-100NB118X	TMC2X-100SS118X	1"	-	0.98	0.79	0.98	0.98	1.10	0.870	1.180	0.94	1.81	1.99	3.15	PVC11	5.11
TMC2X-100A137X	TMC2X-100NB137X	TMC2X-100SS137X	1 ¼"	-	0.98	0.94	1.08	1.08	1.28	1.020	1.370	0.94	2.05	2.26	3.55	PVC15	6.70
TMC2X-125A137X	TMC2X-125NB137X	TMC2X-125SS137X	1 ½"	-	1.01	0.94	1.18	1.18	1.28	1.020	1.370	1.20	2.05	2.26	3.55	PVC15	6.70
TMC2X-125A162X	TMC2X-125NB162X	TMC2X-125SS162X	1 ¾"	-	1.01	1.22	1.35	1.35	1.50	1.300	1.620	1.20	2.36	2.60	3.59	PVC18	8.82
TMC2X-150A162X	TMC2X-150NB162X	TMC2X-150SS162X	1 ¾"	-	1.03	1.22	1.42	1.42	1.50	1.300	1.620	1.46	2.36	2.60	3.59	PVC18	8.82
TMC2X-125A190X	TMC2X-125NB190X	TMC2X-125SS190X	1 ¾"	-	1.01	-	-	1.51	1.72	1.570	1.900	1.20	2.56	2.82	3.59	PVC37	9.45
TMC2X-150A190X	TMC2X-150NB190X	TMC2X-150SS190X	1 ¾"	-	1.03	-	-	1.51	1.72	1.570	1.900	1.46	2.56	2.82	3.59	PVC37	9.45
TMC2X-150A200X	TMC2X-150NB200X	TMC2X-150SS200X	1 ½"	-	1.03	1.57	1.70	1.70	1.8								

TC

TC GLOBALLY APPROVED, HAZARDOUS (CLASSIFIED) LOCATION CABLE GLAND

FOR ALL TYPES OF UNARMORED TRAY CABLES, FLEXIBLE CABLES & CORD

- Aluminum, nickel plated brass or stainless steel design
- Increased cable range with removable insert
- Optional thread sizes
- -60°C to +110°C (-76°F to +230°F)
- Globally marked, cCSAus, IECEX, ATEX and UKEX
- Heavy duty design
- O-ring face seal as standard

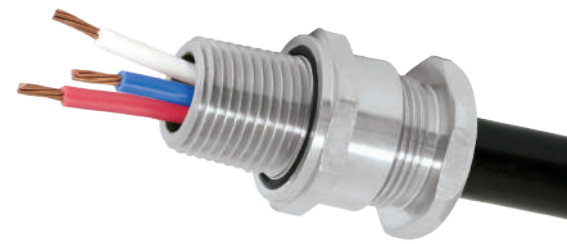

+230 °F
↑
-76 °F

Ex db	AEx e Ex e	AEx t Ex t
-------	---------------	---------------

TECHNICAL CLASSIFICATION	
DESIGN SPECIFICATION	BS 6121:Part 1:1989, IEC 62444, EN 62444
MECHANICAL CLASSIFICATION*	Impact = Level 8, Cable Anchorage = Type B
ENCLOSURE PROTECTION	IK10 to IEC 62262 (20 joules) Brass and Stainless Steel only
INGRESS PROTECTION RATING**	IP66, IP67 and IP68***
NEMA RATING**	Type 4X
CABLE GLAND MATERIAL	Copper Free (<0.4%) Aluminum, Nickel Plated Brass, Stainless Steel
CABLE TYPE	Tray Cable and Cords, Unarmored / Braided (IECs)
SEALING TECHNIQUE	CMP Displacement Seal with Removable Insert
SEALING AREA(S)	Cable Outer Jacket

* Mechanical and Electrical Classifications applied as per IEC 62444 & EN 62444. ** When CMP installation accessories are used. Refer to www.cmp-products.com for further information. *** IP68 tested to a minimum depth of 30 metres for 12 hours, alternative depths / durations can be provided upon request.

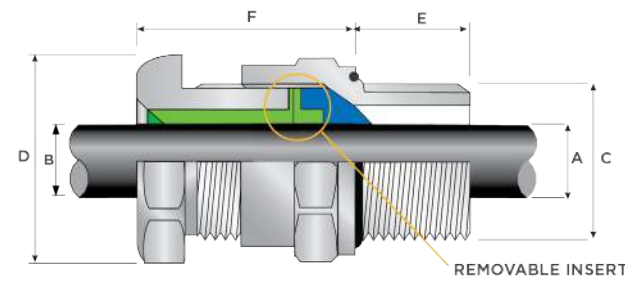

ORDER REFERENCE (NPT)	ENTRY THREAD °C		MINIMUM THREAD LENGTH 'E'	CABLE RANGE 'A'				ACROSS FLATS 'D'	ACROSS CORNERS 'D'	NOMINAL ASSEMBLY LENGTH 'F'	SHROUD	APPROX WEIGHT ALUMINUM (oz)
	NPT	NPT OPTION		INSERT		NO INSERT						
				MIN	MAX	MIN	MAX					
TC-050A028	TC-050NB028	TC-050SS028	1/2"	-	0.78	-	-	1.20	1.32	1.20	PVC06	1.94
TC-075A028	TC-075NB028	TC-075SS028	-	3/4"	0.80	0.13	0.28	1.48	1.63	1.24	PVC09	1.69
TC-050A055	TC-050NB055	TC-050SS055	1/2"	-	0.78	0.26	0.41	1.20	1.32	1.20	PVC06	1.94
TC-075A055	TC-075NB055	TC-075SS055	-	3/4"	0.80	0.26	0.41	1.48	1.63	1.24	PVC09	1.69
TC-075A079	TC-075NB079	TC-075SS079	3/4"	-	0.80	0.44	0.61	1.48	1.63	1.24	PVC09	1.69
TC-100A079	TC-100NB079	TC-100SS079	-	1"	0.98	0.44	0.61	1.81	1.99	1.65	PVC11	3.17
TC-100A104	TC-100NB104	TC-100SS104	1"	-	0.98	0.67	0.85	1.81	1.99	1.65	PVC11	3.88
TC-125A104	TC-125NB104	TC-125SS104	-	1 1/4"	1.01	0.67	0.85	2.05	2.25	1.65	PVC13	3.88
TC-125A127	TC-125NB127	TC-125SS127	1 1/4"	-	1.01	0.93	1.10	2.05	2.25	1.65	PVC13	4.94
TC-150A127	TC-150NB127	TC-150SS127	-	1 1/2"	1.03	0.93	1.10	2.36	2.60	1.65	PVC18	4.94
TC-150A150	TC-150NB150	TC-150SS150	1 1/2"	-	1.03	1.22	1.37	2.36	2.60	1.65	PVC18	6.00
TC-200A150	TC-200NB150	TC-200SS150	-	2"	1.06	1.22	1.37	2.95	3.25	1.65	PVC23	6.00
TC-200A174	TC-200NB174	TC-200SS174	2"	-	1.06	-	1.40	2.76	3.03	1.63	PVC21	8.64
TC-250A174	TC-250NB174	TC-250SS174	-	2 1/2"	1.57	-	1.74	3.54	3.90	1.74	PVC27	8.29
TC-200A197	TC-200NB197	TC-200SS197	2"	-	1.06	-	1.63	2.76	3.03	1.74	PVC21	8.29
TC-250A197	TC-250NB197	TC-250SS197	-	2 1/2"	1.57	-	1.97	3.54	3.90	1.74	PVC27	8.29
TC-250A220	TC-250NB220	TC-250SS220	2 1/2"	-	1.57	-	1.86	3.54	3.90	1.74	PVC27	13.58
TC-300A220	TC-300NB220	TC-300SS220	-	3"	1.63	-	2.20	4.33	4.77	1.74	PVC31	13.58
TC-250A244	TC-250NB244	TC-250SS244	2 1/2"	-	1.57	-	2.13	3.54	3.90	1.79	PVC28	13.58
TC-300A244	TC-300NB244	TC-300SS244	-	3"	1.63	-	2.44	4.33	4.77	1.79	PVC31	13.58
TC-300A268	TC-300NB268	TC-300SS268	3"	-	1.63	-	2.68	4.33	4.77	1.79	PVC31	23.63
TC-350A268	TC-350NB268	TC-350SS268	-	3 1/2"	1.69	-	-	4.84	5.33	-	LSF32	34.22
TC-350A315	TC-350NB315	TC-350SS315	3 1/2"	-	1.69	-	3.15	4.84	5.33	2.50	LSF33	34.22
TC-400A315	TC-400NB315	TC-400SS315	-	4"	1.73	-	-	5.25	5.78	-	LSF33	34.22
TC-400A354	TC-400NB354	TC-400SS354	4"	-	1.73	-	3.54	5.25	5.78	2.36	LSF34	38.80

Order code example: TC-050A028 - "TC" (Type Gland) - "050" (1/2" NPT Thread) - "A" (Material Aluminum) - "028" (Max Cable Diameter 0.28")

Dimensions are displayed in inches unless otherwise stated

A2F

A2F GLOBALLY APPROVED, HAZARDOUS (CLASSIFIED) LOCATION CABLE GLAND

FOR ALL TYPES OF UNARMORED & BRAIDED CABLES

- Aluminum, nickel plated brass or stainless steel
- Optional thread sizes
- Displacement type flameproof seal
- Deluge protected
- -60°C to +130°C (-76°F to +266°F)
- Globally marked, UKEX, IECEX, ATEX and CSA
- As standard in nickel plated brass with NPT thread form

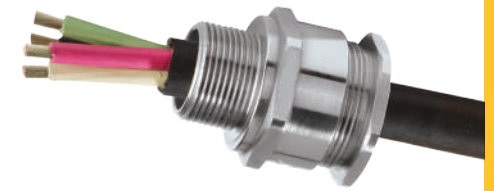

+266 °F
↑
-76 °F

Ex db	Ex eb	Ex ta	Ex nR
-------	-------	-------	-------

TECHNICAL CLASSIFICATION	
DESIGN SPECIFICATION	BS 6121:Part 1:1989, IEC 62444, EN 62444
MECHANICAL CLASSIFICATION*	Impact = Level 8, Cable Anchorage = Type B
ENCLOSURE PROTECTION	IK10 to IEC 62262 (20 joules) Brass & Stainless Steel only
INGRESS PROTECTION RATING**	IP66, IP67 & IP68***
NEMA RATING**	NEMA 4X
DELUGE PROTECTION COMPLIANCE	DTS01 : 91
CABLE TYPE	Unarmored & Braided (when terminated inside enclosure)
SEAL MATERIAL	CMP SOLO LSF Halogen Free Thermoset Elastomer
SEALING TECHNIQUE	CMP Unique Displacement Seal Concept
SEALING AREA(S)	Cable Outer Jacket
CABLE GLAND MATERIAL	Copper Free (<0.4%) Aluminum, Nickel Plated Brass, Stainless Steel

* Mechanical and Electrical Classifications applied as per IEC 62444 and EN 62444 ** When CMP installation accessories are used. Refer to www.cmp-products.com for further information. *** IP68 tested to a minimum depth of 30 metres for 12 hours, alternative depths / durations can be provided upon request.

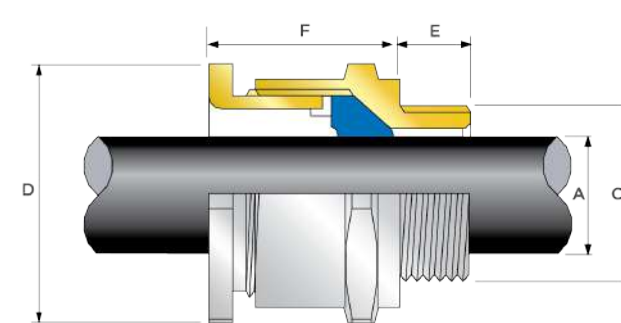

GLOBAL PRODUCT CERTIFICATION			
ATEX CERTIFICATE	CML18ATEX1321X, CML18ATEX4313X	IECEX CERTIFICATE	IECEX CML 18.0179X
UKEX CERTIFICATE	CML 21UKEX1249X, CML 21UKEX4250X	IECEX CERTIFICATE	IECEX CML 18.0179X
CODE OF PROTECTION	Ⓜ II 2G 1D Ex db IIC Gb, Ex eb IIC Gb, Ex ta IIC Da	CODE OF PROTECTION	Ex db IIC Gb, Ex eb IIC Gb, Ex nR IIC Gc, Ex ta IIC Da
COMPLIANCE STANDARDS	EN 60079-0,1,7,15,31	COMPLIANCE STANDARDS	IEC 60079-0,1,7,15,31
CSAus CERTIFICATE	1211841	IECEX CERTIFICATE	IECEX CML 18.0179X
CODE OF PROTECTION	Ex d IIC, Ex e II, Ex nR II; Encl. Type 4x	IECEX CERTIFICATE	IECEX CML 18.0179X
COMPLIANCE STANDARDS	C22.2 No 0,0,4,94,174, CAN/CSA-60079-0,1,7,15	IECEX CERTIFICATE	IECEX CML 18.0179X
ECAS CERTIFICATE	20-02-05632	UKEX CERTIFICATE	CLJ 19.0371X
EAC CERTIFICATE	RU C-GB.A.07.B.02519/20	UKEX CERTIFICATE	CLJ 19.0371X
KCS CERTIFICATE	13_GA4B0_0748X; 13_GA4B0_0749X; 13_GA4B0_0750X; 14_GA4B0_0251X	UKEX CERTIFICATE	CLJ 19.0371X
INMETRO APPROVAL	TUV 21.1075X	UKEX CERTIFICATE	CLJ 19.0371X
CCOE / PESO (INDIA) CERTIFICATE	P548696, P533772, P548695	RETIE APPROVAL NUMBER	03866
MARINE APPROVALS	LRS: LR22320739TA, DNV: TAE000000Y, ABS: 20-2022051-PDA, BV: 43180	RETIE APPROVAL NUMBER	03866



SIZE	TYPE	ORDERING SUFFIX	AVAILABLE ENTRY THREADS °C				OVERALL CABLE DIAMETER 'A'		ACROSS FLATS 'D'	ACROSS CORNERS 'D'	PROTRUSION LENGTH 'F'	SHROUD	APPROX WEIGHT ALUMINUM (oz)
			NPT	NPT (OPTION)	METRIC (OPTION)	THREAD LENGTH (NPT) 'E'	MIN	MAX					
20S16	A2F	1RA531	1/2"	3/4"	M20	0.78	0.13	0.34	0.95	1.04	1.04	PVC04	2.30
20S	A2F	1RA531	1/2"	3/4"	M20	0.78	0.24	0.46	0.95	1.04	1.00	PVC04	2.02
20	A2F	1RA531	1/2"	3/4"	M20	0.78	0.26	0.55	1.06	1.17	1.06	PVC05	2.04
25	A2F	1RA532	3/4"	1"	M25	0.80	0.44	0.79	1.42	1.56	1.40	PVC09	3.66
32	A2F	1RA533	1"	1 1/4"	M32	0.98	0.67	1.04	1.61	1.78	1.35	PVC10	4.45
40	A2F	1RA534	1 1/4"	1 1/2"	M40	1.01	0.93	1.27	1.97	2.17	1.37	PVC13	6.64
50S	A2F	1RA535	1 1/2"	2"	M50	1.03	1.22	1.50	2.17	2.38	1.34	PVC15	8.12
50	A2F	1RA536	2"	2 1/2"	M50	1.06	1.40	1.73	2.56	2.82	1.52	PVC18	15.26
63S	A2F	1RA536	2"	2 1/2"	M63	1.06	1.63	1.97	2.76	3.03	1.42	PVC21	12.41
63	A2F	1RA537	2 1/2"	3"	M63	1.57	1.86	2.20	3.15	3.47	1.41	PVC23	25.55
75S	A2F	1RA537	2 1/2"	3"	M75	1.57	2.13	2.44	3.15	3.47	1.46	PVC24	18.54
75	A2F	1RA538	3"	3 1/2"	M75	1.63	2.41	2.67	3.94	4.33	1.58	PVC24	44.56
90	A2F	1RA539	3 1/2"	4"	M90	1.69	2.62	3.15	4.25	4.68	2.18	PVC31	59.90
100	A2F	1RA539	3 1/2"	4"	M100	1.69	2.99	3.58	4.85	5.34	2.19	LSF33	52.90
115	A2F	1RA5310	4"	5"	M115	1.73	3.39	3.85	5.25	5.78	2.57	LSF34	76.71
130	A2F	1RA5311	5"	-	M130	1.84	3.82	4.52	6.00	6.60	2.91	LSF35	138.91

*For material options add the following suffix to the ordering reference; Brass (no suffix required); Nickel Plated Brass '5'; 316 Grade Stainless Steel '4'; Copper Free Aluminum '1' For NPT options add the following digits to the material suffix; 1/2" = 31; 3/4" = 32; 1" = 33; 1 1/4" = 34; 1 1/2" = 35; 2" = 36; 2 1/2" = 37; 3" = 38; 3 1/2" = 39; 4" = 310 (Brass requires prefix '0')

Examples: 32A2F1RA534 = Nickel Plated Brass 1 1/4" NPT, 25A2F1RA432 = Stainless Steel 3/4" NPT, 20A2F1RA5 = Nickel Plated Brass M20

Dimensions are displayed in inches unless otherwise stated

CG CORD GRIP, WET, DRY, ORDINARY OR HAZARDOUS LOCATION CABLE GLAND

FOR USE WITH FLEXIBLE CABLES & CORDS

- Fully machined from high grade series 6000 aluminum or zinc plated steel
- Can also be supplied in stainless steel or nickel plated brass on request
- Product supplied with entry thread seal and locknut
- Safe sealing solution manufactured from LSF halogen-free thermoset elastomer, with a large temperature range of -76°F to +194°F
- Wide cable sealing range
- Easy to install
- Approved to the latest edition of UL 514B and CSA C22.2 No.18.3-12
- Suitable for use in hazardous locations when installed per National Electrical Code (NEC 501.10(B)(4)) & Canadian Electrical Code (CSA 22.1)
- Strain relief available



TECHNICAL DATA	
INGRESS PROTECTION RATING**	IP66, IP67 & IP68***
NEMA RATING**	NEMA 4X, 6P
CABLE GLAND MATERIAL	Aluminum, Zinc Plated Steel, Stainless Steel, Nickel Plated Brass
SEAL MATERIAL	CMP SOLO LSF Halogen Free Thermoset Elastomer
CABLE TYPE	Flexible cables and cords
SEALING TECHNIQUE	CMP displacement seal
SEALING AREA(S)	Cable outer sheath

PRODUCT CERTIFICATION	
UL APPROVAL	E509101*
COMPLIANCE STANDARDS	UL514B, UL50E, CSA C22.2 No.18.3-12, CSA C22.2 No.94.2-15



HOW TO ORDER

EXAMPLE ORDERING
CG CORD GRIP - 1/2" NPT - ALUMINUM - 0.54" MAX CABLE RANGE (CG-050A054)

CG-	OS0	A	OS4
Type	Thread Size	Material	Max Cable Outer Diameter
CG-	0375	3/8"	0.46
	050	1/2"	0.54
	075	3/4"	0.80
	100	1"	1.04
	125	1 1/4"	1.28
	150	1 1/2"	1.49
	200	2"	1.74

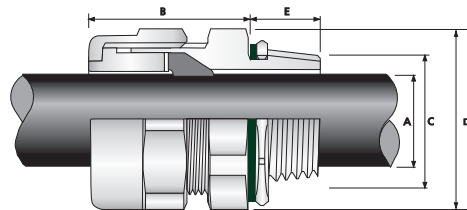

ORDER REFERENCE (NPT)		ENTRY THREAD 'C'	MINIMUM THREAD LENGTH 'E'	CABLE RANGE 'A'		ACROSS FLATS 'D'	ACROSS CORNERS 'D'	NOMINAL ASSEMBLY LENGTH 'B'
ALUMINUM	ZINC PLATED STEEL			MIN	MAX			
*CG-0375A046	*CG-0375MS046	3/8"	0.41			0.94	1.04	1.15
CG-050A046	CG-050MS046	1/2"	0.53	0.30	0.46	0.94	1.04	1.15
CG-075A046	CG-075MS046	3/4"	0.55			1.20	1.32	1.18
CG-100A046	CG-100MS046	1"	0.68			1.48	1.63	1.22
CG-050A054	CG-050MS054	1/2"	0.53			1.20	1.32	1.13
CG-075A054	CG-075MS054	3/4"	0.55	0.30	0.54	1.48	1.63	1.17
CG-100A054	CG-100MS054	1"	0.68			1.48	1.63	1.21
CG-075A080	CG-075MS080	3/4"	0.55	0.51	0.80	1.48	1.63	1.47
CG-100A080	CG-100MS080	1"	0.68			1.48	1.63	1.51
CG-100A104	CG-100MS104	1"	0.68	0.75	1.04	1.73	1.91	1.42
CG-125A104	CG-125MS104	1 1/4"	0.71			1.97	2.17	1.42
CG-150A104	CG-150MS104	1 1/2"	0.72			2.17	2.38	1.50
CG-125A128	CG-125MS128	1 1/4"	0.71			2.17	2.38	1.45
CG-150A128	CG-150MS128	1 1/2"	0.72	0.91	1.28	2.17	2.38	1.53
CG-150A149	CG-150MS149	1 1/2"	0.72			2.36	2.60	1.56
CG-200A149	CG-200MS149	2"	0.76	1.22	1.49	2.56	2.81	1.56
CG-200A174	CG-200MS174	2"	0.76			2.56	2.81	1.57

Dimensions are displayed in inches unless otherwise stated

Additional combinations of body size and thread are available upon request.
*All sizes UL Listed, except NPT 3/8" - UL Recognized Component

WIRE MESH STRAIN RELIEF FOR USE WITH CG CORD GRIP IN WET, DRY, ORDINARY OR HAZARDOUS LOCATIONS

FOR USE WITH FLEXIBLE CABLES & CORDS

- Designed to alleviate excessive load on the cable gland
- Easy to install
- Approved to the latest edition of UL 514B and CSA C22.2 No.18.3-12
- Suitable for use in hazardous locations when installed per National Electrical Code (NEC 501.10(B)(4)) and Canadian Electrical Code (CSA 22.1)
- Only to be used with CMP CG Cord Grip cable gland



TECHNICAL DATA	
MATERIAL	Aluminum & Galvanized mild steel
CABLE TYPE	Flexible cables and cords

PRODUCT CERTIFICATION	
UL APPROVAL	E509101*
COMPLIANCE STANDARDS	UL514B, UL50E, CSA C22.2 No.18.3-12, CSA C22.2 No.94.2-15**

*All sizes UL Listed, except NPT 3/8" - UL Recognized Component
** When used with CMP CG Cord Grip cable gland

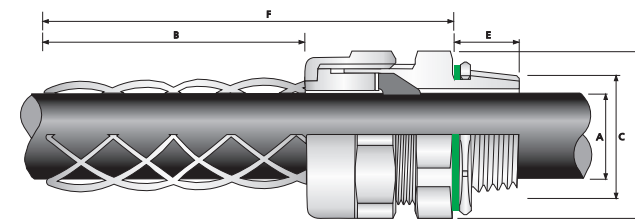

Order reference for CG Strain Relief only. Dimensional data on CG Cord Grip for reference only.

ORDER REFERENCE	COMPATIBLE CG		ENTRY THREAD 'C'	MINIMUM THREAD LENGTH 'E'	CABLE RANGE 'A'		ACROSS FLATS 'D'	ACROSS CORNERS 'D'	STRAIN RELIEF LENGTH 'B'	NOMINAL ASSEMBLY LENGTH 'F'
	ALUMINUM	ZINC PLATED STEEL			MIN	MAX				
SRA046	*CG-0375A046	*CG-0375MS046	3/8"	0.41	0.30	0.46	0.94	1.04	6.23 - 6.35	7.38 - 7.50
	CG-050A046	CG-050MS046	1/2"	0.53			0.94	1.04	6.23 - 6.35	7.38 - 7.50
	CG-075A046	CG-075MS046	3/4"	0.55			1.20	1.32	6.26 - 6.38	7.44 - 7.56
	CG-100A046	CG-100MS046	1"	0.68			1.48	1.63	6.29 - 6.41	7.51 - 7.63
SRA054	CG-050A054	CG-050MS054	1/2"	0.53	0.30	0.54	1.20	1.32	7.67 - 7.78	8.80 - 8.91
	CG-075A054	CG-075MS054	3/4"	0.55			1.48	1.63	7.71 - 7.82	8.88 - 8.99
	CG-100A054	CG-100MS054	1"	0.68			1.48	1.63	7.75 - 7.86	8.96 - 9.07
SRA080	CG-075A080	CG-075MS080	3/4"	0.55	0.51	0.80	1.48	1.63	8.56 - 8.75	10.03 - 10.22
	CG-100A080	CG-100MS080	1"	0.68			1.48	1.63	8.60 - 8.79	10.11 - 10.30
SRA104	CG-100A104	CG-100MS104	1"	0.68	0.75	1.04	1.73	1.91	10.67 - 10.87	12.09 - 12.29
	CG-125A104	CG-125MS104	1 1/4"	0.71			1.97	2.17	10.67 - 10.87	12.09 - 12.29
	CG-150A104	CG-150MS104	1 1/2"	0.72			2.17	2.38	10.75 - 10.95	12.25 - 12.45
SRA128	CG-125A128	CG-125MS128	1 1/4"	0.71	0.91	1.28	2.17	2.38	13.38 - 13.58	14.83 - 15.03
	CG-150A128	CG-150MS128	1 1/2"	0.72			2.17	2.38	13.46 - 13.66	14.99 - 15.19
SRA149	CG-150A149	CG-150MS149	1 1/2"	0.72	1.22	1.49	2.36	2.60	14.95 - 15.14	16.51 - 16.70
	CG-200A149	CG-200MS149	2"	0.76			2.56	2.81	14.95 - 15.14	16.51 - 16.70
SRA174	CG-200A174	CG-200MS174	2"	0.76	1.43	1.74	2.56	2.81	15.19 - 15.43	16.76 - 17.00

Dimensions are displayed in inches unless otherwise stated

Additional combinations of body size and thread are available upon request.
*All sizes UL Listed, except NPT 3/8" - UL Recognized Component

PXSS2K

PXSS2K GLOBALLY APPROVED, HAZARDOUS (CLASSIFIED) LOCATION BARRIER CABLE GLAND

FOR ALL TYPES OF UNARMORED CABLES

- Direct and remote installation
- Superior levels of cable retention
- Displacement type environmental seal
- Compound barrier type flameproof seal
- Deluge protected
- Disconnectable, union feature design
- -60°C to +85°C (-76°F to +185°F)
- Globally marked, UL, cCSAus, IECEx, ATEX and UKEX
- As standard in nickel plated brass with NPT thread form
- Compound barrier seals around internal cable cores after removing any inner cable sheath/bedding; completely eliminating any risk of coldflow



TECHNICAL CLASSIFICATION	
DESIGN SPECIFICATION	BS 6121:Part 1:1989, IEC 62444, EN 62444
MECHANICAL CLASSIFICATIONS*	Impact = Level 8, Cable Anchorage = Type B
ENCLOSURE PROTECTION	IK10 to IEC 62262 (20 joules) Brass and Stainless Steel only
INGRESS PROTECTION RATING**	IP66, IP67 and IP68****
NEMA RATING**	Type 4X
DELUGE PROTECTION COMPLIANCE	DTS01 : 91
CABLE GLAND MATERIAL	Electroless Nickel Plated Brass, Copper Free (<0.4%) Aluminum, Stainless Steel
SEAL MATERIAL	CMP SOLO LSF Halogen Free Thermoset Elastomer / Epoxy Barrier Compound
CABLE TYPE	Unarmored***
SEALING TECHNIQUE	CMP Displacement Seal
SEALING AREA(S)	Inner Compound Barrier and Outer Sheath

* Mechanical and Electrical Classifications applied as per IEC 62444 and EN 62444 ** Where CMP installation accessories are used. Refer to www.cmp-products.com for further information. *** Where the cable is permitted by code (NEC and/or CEC) **** IP68 tested to a minimum depth of 30 metres for 12 hours, alternative depths / durations can be provided upon request.

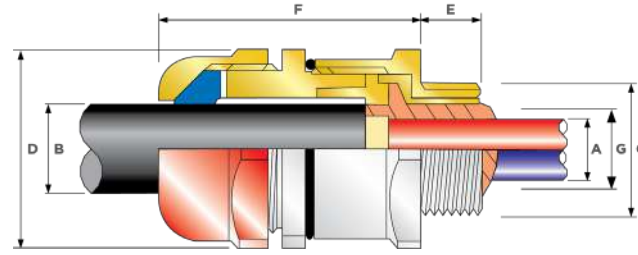

GLOBAL PRODUCT CERTIFICATION			
ATEX CERTIFICATE	CML18ATEX1325X, CML18ATEX4317X	IECEx CERTIFICATE	IECEx CML 18.0182X
UKEX CERTIFICATE	CML 21UKEX1214X, CML 21UKEX4215X	IECEx CERTIFICATE	IECEx CML 18.0182X
CODE OF PROTECTION	Ⓜ II 2G 1D, Ex db IIC Gb, Ex eb IIC Gb, Ex ta IIIC Da Ⓜ II 3G, Ex nR IIC Gc Ⓜ I M2 Ex db I Mb*, Ex eb I Mb*	CODE OF PROTECTION	Ex db IIC Gb, Ex eb IIC Gb, Ex nR IIC Gc, Ex ta IIIC Da, Ex db I Mb*, Ex eb I Mb*
COMPLIANCE STANDARDS	EN 60079-0,1,7,15,31	COMPLIANCE STANDARDS	IEC 60079-0,1,7,15,31
cSAUS CERTIFICATE (20S16-90)	2288626		
CSAus CODE OF PROTECTION**	Class I, Div 1 and 2, Groups A, B, C, and D; Class II, Div 1 and 2, Groups E, F, and G; Class III, Div 1 and 2; Type 4X; Oil Resistance II; Class I, Zone 1, AEx d IIC Gb, AEx e IIC Gb; Class I, Zone 2, AEx nR IIC Gc; Class I, Zone 20, AEx ta IIIC Da		
cSA CODE OF PROTECTION**	Class I, Div 1 and 2, Groups A, B, C, and D; Class II, Div 2, Groups F and G; Class III, Div 1 and 2; Type 4X; Oil Resistance II; Ex d IIC Gb, Ex e IIC Gb, Ex nR IIC Gc, Ex ta IIIC Da		
COMPLIANCE STANDARDS	CAN/CSA-C22.2 No 0.18,25,30,174,94, CAN/CSA-C22.2 No 60079-1,7,15,31, CAN/CSA-E61241-1-1, ANSI/UL 514B, ANSI/UL 50, ANSI 2225, ANSI/ISA 60079-31, UL60079-0,1,7,15		
cULUS CERTIFICATE	E201187, E253914, E161256		
CODE OF PROTECTION**	Class I, Div 1 and 2, Groups A, B, C, and D; Class II, Div 1 and 2, Groups F and G; Class I, Zone 1, AEx d IIC, AEx e II		
COMPLIANCE STANDARDS	UL 2225, UL 514B, UL 60079-0, UL 60079-7, CSA C22.2 No. 174		
ECAS CERTIFICATE	20-02-05624	UKrSEPRO CERTIFICATE	CL1 19.0371X
EAC CERTIFICATE	TC RU C-GB.A07.B.04595/22		
CODE OF PROTECTION	1Ex d IIC Gb X, 1Ex e IIC Gb X, 2Ex nR IIC Gc X, Ex ta IIIC Da X, IP66, IP67, IP68		
IECEx CERTIFICATE	14_GA4BO_0252X		
RETIE APPROVAL NUMBER	03866	CCOE / PESO (INDIA) CERTIFICATE	P548696, P533772, P548695
CCC CERTIFICATE	2020322313003190	INMETRO APPROVAL	TUV 12.2073X
MARINE APPROVALS	LRS: LR22320739TA, DNV: TAE000000V, ABS: 20-LD1948801-PDA, BV: 43180		

*Aluminum alloys are not permitted in Group I mining applications
 **Where the cable is permitted by code (NEC and/or CEC)



COMBINED ORDERING REFERENCE (*NICKEL PLATED BRASS NPT)			AVAILABLE ENTRY THREADS 'C' (ALTERNATIVE METRIC THREAD LENGTHS AVAILABLE)				NUMBER OF CORES	DIAMETER OVER CONDUCTORS 'A'		CABLE BEDDING DIAMETER 'G'		OVERALL CABLE DIAMETER 'B'		ACROSS FLATS 'D'		ACROSS CORNERS 'D'		PROTRUSION LENGTH 'F'	SHROUD	APPROX WEIGHT ALUMINUM (oz)
SIZE	TYPE	ORDERING SUFFIX	NPT	NPT (OPTION)	METRIC (OPTION)	THREAD LENGTH (NPT) 'E'		MAX	MIN	MAX	MIN	MAX	MAX	MAX	MAX	MAX				
20S16	PXSS2K	1RA531	1/2"	3/4"	M20	0.78	21	0.34	0.34	0.12	0.34	1.18	1.30	2.09	PVC06	7.06				
20S	PXSS2K	1RA531	1/2"	3/4"	M20	0.78	21	0.46	0.46	0.24	0.46	1.18	1.30	2.09	PVC06	7.06				
20	PXSS2K	1RA531	1/2"	3/4"	M20	0.78	21	0.50	0.51	0.26	0.55	1.18	1.30	2.13	PVC06	7.06				
20L	PXSS2K	1RA531	1/2"	3/4"	M20	0.78	21	0.50	0.51	0.41	0.63	1.18	1.30	2.13	PVC06	7.06				
25	PXSS2K	1RA532	3/4"	1"	M25	0.80	30	0.69	0.70	0.44	0.79	1.42	1.56	2.36	PVC09	11.64				
32	PXSS2K	1RA533	1"	1 1/4"	M32	0.98	38	0.93	0.94	0.67	1.04	1.61	1.78	2.41	PVC10	13.76				
32L	PXSS2K	1RA533	1"	1 1/4"	M32	0.98	38	0.93	0.94	0.79	1.08	1.61	1.78	2.41	PVC10	13.76				
40	PXSS2K	1RA534	1 1/4"	1 3/4"	M40	1.01	59	1.18	1.19	0.87	1.26	1.97	2.17	2.46	PVC13	19.75				
50S	PXSS2K	1RA535	1 1/2"	2"	M50	1.03	89	1.44	1.45	1.16	1.50	2.17	2.38	2.57	PVC15	23.28				
50	PXSS2K	1RA536	2"	2 1/2"	M50	1.06	115	1.61	1.63	1.40	1.73	2.76	3.03	2.66	PVC21	25.75				
63S	PXSS2K	1RA536	2"	2 1/2"	M63	1.06	115	1.89	1.91	1.58	1.97	2.76	3.03	2.80	PVC21	37.74				
63	PXSS2K	1RA537	2 1/2"	3"	M63	1.57	115	2.11	2.13	1.86	2.20	3.15	3.47	2.77	PVC25	37.39				
75S	PXSS2K	1RA537	2 1/2"	3"	M75	1.57	140	2.36	2.37	2.08	2.44	3.15	3.47	2.97	PVC25	45.86				
75	PXSS2K	1RA538	3"	3 1/2"	M75	1.63	140	2.53	2.54	2.33	2.67	3.94	4.33	2.95	PVC30	45.86				
90	PXSS2K	1RA539	3 1/2"	4"	M90	1.69	140	2.96	2.98	2.62	3.13	4.25	4.68	3.73	PVC31	106.53				
100	PXSS2K	1RA539	3 1/2"	4"	M100	1.69	200	3.29	3.30	2.99	3.58	4.84	5.33	3.40	LSF33	141.10				

*Note: For material options please change the suffix in the ordering reference; Brass (no suffix required), Nickel Plated Brass "S" (as standard), 316 Grade Stainless Steel "4", Copper Free Aluminum "1". For NPT options please change the following digits after the material suffix; 1/2" = 31, 3/4" = 32, 1" = 33, 1 1/4" = 34, 1 1/2" = 35, 2" = 36, 2 1/2" = 37, 3" = 38, 3 1/2" = 39 (Brass requires prefix "0")

Examples: 32PXSS2K1RA534 = Nickel Plated Brass 1 1/4" NPT, 25PXSS2K1RA432 = Stainless Steel 3/4" NPT, 20PXSS2K1RA5 Nickel Plated Brass M20
 Dimensions are displayed in inches unless otherwise stated

PXSS2KREX

PXSS2KREX GLOBALLY APPROVED, HAZARDOUS (CLASSIFIED) LOCATION BARRIER CABLE GLAND

FOR ALL TYPES OF UNARMORED CABLES

- RapidEx liquid pour sealing system reduces installation time
- Direct and remote installation
- Superior levels of cable retention
- Displacement type environmental seal
- Deluge protected
- Disconnectable, union feature design
- -60°C to +85°C (-76°F to +185°F)
- Globally marked, UL, cCSAus, IECEx, ATEX and UKEX
- As standard in nickel plated brass with NPT thread form
- RapidEx liquid barrier resin seals around internal cable cores after removing any cable inner sheath/bedding; completely eliminating any risk of coldflow



TECHNICAL CLASSIFICATION	
DESIGN SPECIFICATION	BS 6121:Part 1:1989, IEC 62444, EN 62444
MECHANICAL CLASSIFICATIONS*	Impact = Level 8, Cable Anchorage = Type B
ENCLOSURE PROTECTION	IK10 to IEC 62262 (20 joules) Brass and Stainless Steel only
INGRESS PROTECTION RATING**	IP66, IP67 and IP68****
NEMA RATING**	Type 4X
DELUGE PROTECTION COMPLIANCE	DTS01 : 91
CABLE TYPE	Unarmored***
SEAL MATERIAL	CMP SOLO LSF Halogen Free Thermoset Elastomer / RapidEx Barrier Compound
SEALING TECHNIQUE	CMP Outer Displacement Seal and Inner RapidEx Barrier Seal
SEALING AREA(S)	RapidEx Resin Barrier and Cable Outer Sheath
CABLE GLAND MATERIAL	Electroless Nickel Plated Brass, Copper Free (<0.4%) Aluminum, Stainless Steel

* Mechanical and Electrical Classifications applied as per IEC 62444 and EN 62444 ** Where CMP installation accessories are used. Refer to www.cmp-products.com for further information. ***Where the cable is permitted by code (NEC and/or CEC) **** IP68 tested to a minimum depth of 30 metres for 12 hours, alternative depths/durations can be provided upon request.

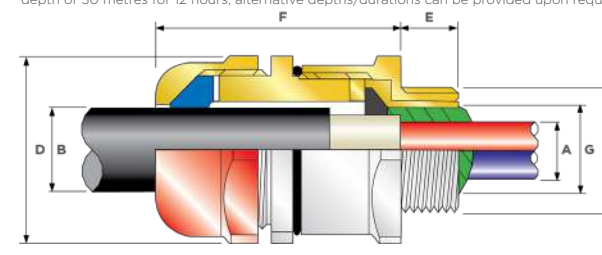

PATENT GRANTED: ES2287986, NO 2287986, TR 2287986, AU 2010284848, AU 2014274614, GB 2485114, SG 178839, US 8872027, US 9484133, US 9774178, MY 153843, US 10193321, US 1034078



COMBINED ORDERING REFERENCE (*NICKEL PLATED BRASS NPT)			AVAILABLE ENTRY THREADS 'C' (ALTERNATIVE METRIC THREAD LENGTHS AVAILABLE)				NUMBER OF CORES	DIAMETER OVER CONDUCTORS 'A'		CABLE BEDDING DIAMETER 'G'		OVERALL CABLE DIAMETER 'B'		ACROSS FLATS 'D'		ACROSS CORNERS 'D'		PROTRUSION LENGTH 'F'	SHROUD	APPROX WEIGHT ALUMINUM (oz)
SIZE	TYPE	ORDERING SUFFIX	NPT	NPT (OPTION)	METRIC (OPTION)	THREAD LENGTH (NPT) 'E'		MAX	MIN	MAX	MIN	MAX	MAX	MAX	MAX	MAX				
20S16	PXSS2KREX	1EX531	1/2"	3/4"	M20	0.78	21	0.34	0.34	0.12	0.34	1.18	1.30	2.09	PVC06	7.06				
20S	PXSS2KREX	1EX531	1/2"	3/4"	M20	0.78	21	0.46	0.46	0.24	0.46	1.18	1.30	2.09	PVC06	7.06				
20	PXSS2KREX	1EX531	1/2"	3/4"	M20	0.78	21	0.50	0.51	0.26	0.55	1.18	1.30	2.13	PVC06	7.06				
20L	PXSS2KREX	1EX531	1/2"	3/4"	M20	0.78	21	0.50	0.51	0.41	0.63	1.18	1.30	2.13	PVC06	7.06				
25	PXSS2KREX	1EX532	3/4"	1"	M25	0.80	30	0.69	0.70	0.44	0.79	1.42	1.56	2.36	PVC09	11.64				
32	PXSS2KREX	1EX533	1"	1 1/4"	M32	0.98	50	0.93	0.94	0.67	1.04	1.61	1.78	2.41	PVC10	13.76				
32L	PXSS2KREX	1EX533	1"	1 1/4"	M32	0.98	50	0.93	0.94	0.79	1.08	1.61	1.78	2.41	PVC10	13.76				
40	PXSS2KREX	1EX534	1 1/4"	1 3/4"	M40	1.01	59	1.18	1.19	0.87	1.26	1.97	2.17	2.46	PVC13	19.75				
50S	PXSS2KREX	1EX535	1 1/2"	2"	M50	1.03	89	1.44	1.45	1.16	1.50	2.17	2.38	2.57	PVC15	23.28				
50	PXSS2KREX	1EX536	2"	2 1/2"	M50	1.06	115	1.61	1.63	1.40	1.73	2.76	3.03	2.66	PVC21	25.75				
63S	PXSS2KREX	1EX536	2"	2 1/2"	M63	1.06	115	1.89	1.91	1.58	1.97	2.76	3.03	2.80	PVC21	37.74				
63	PXSS2KREX	1EX537	2 1/2"	3"	M63	1.57	115	2.11	2.13	1.86	2.20	3.15	3.47	2.77	PVC25	37.39				
75S	PXSS2KREX	1EX537	2 1/2"	3"	M75	1.57	140	2.36	2.37	2.08	2.44	3.15	3.47	2.97	PVC25	45.86				
75	PXSS2KREX	1EX538	3"	3 1/2"	M75	1.63	140	2.53	2.54	2.33	2.67	3.94	4.33	2.95	PVC30	45.86				
90	PXSS2KREX	1EX539	3 1/2"	4"	M90	1.69	140	2.96	2.98	2.62	3.13	4.25	4.68	3.73	PVC31	106.53				
100	PXSS2KREX	1EX539	3 1/2"	4"	M100	1.69	200	3.29	3.30	2.99	3.58	4.84	5.33	3.40	LSF33	141.10				

*Note: For material options please change the suffix in the ordering reference; Brass (no suffix required), Nickel Plated Brass "S" (as standard), 316 Grade Stainless Steel "4", Copper Free Aluminum "1". For NPT options please change the following digits after the material suffix; 1/2" = 31, 3/4" = 32, 1" = 33, 1 1/4" = 34, 1 1/2" = 35, 2" = 36, 2 1/2" = 37, 3" = 38, 3 1/2" = 39 (Brass requires prefix "0")

Examples: 32PXSS2KREX1EX534 = Nickel Plated Brass 1 1/4" NPT, 25PXSS2KREX1EX432 = Stainless Steel 3/4" NPT, 20PXSS2KREX1EX5 Nickel Plated Brass M20
 Dimensions are displayed in inches unless otherwise stated

T3CDS TRITON CDS

TRITON CDS (T3CDS) GLOBALLY APPROVED, HAZARDOUS (CLASSIFIED) LOCATION CABLE GLAND

FOR ALL TYPES OF ARMORED CABLES

- Fully sequential, three step installation procedure
Reduces installation times, cost and risk
Direct and remote installation
Unique compensating displacement seal system (CDS)
Metal-to-metal installation every time regardless of cable diameter
Designed to reduce the effects of coldflow. See CMP Technical Doc



IP66 IP67 IP68 NEMA 4X
DELUGE PROTECTED EMC +266°F / -76°F
Ex d AEx e AEx nR Ex e Ex nR

Table with 2 columns: TECHNICAL CLASSIFICATION, GLOBAL PRODUCT CERTIFICATION. Includes design specification, mechanical classification, enclosure protection, electrical classification, ingress protection rating, NEMA rating, deluge protection compliance, cable gland material, seal material, cable type(s), armor clamping, sealing technique, and sealing area(s).

Table with 2 columns: GLOBAL PRODUCT CERTIFICATION. Includes ATEX certificate, UKEX certificate, code of protection, compliance standards, CSAus certificate, CSAus code of protection, UL certificate, ECAS certificate, EAC certificate, code of protection, RETIE approval number, CCC certificate, SANS, and marine approvals.

* Mechanical and Electrical Classifications applied as per IEC 62444 and EN 62444 ** When CMP installation accessories are used. Refer to www.cmp-products.com for further information.
*** IP68 tested to a minimum depth of 30 metres for 12 hours, alternative depths / durations can be provided upon request

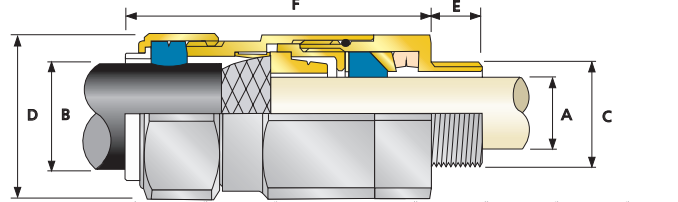

1 Grooved Cone (X) is predominantly used for Wire Braid (e.g. GSWB, TCWB), Steel Tape Armor (STA, DSTA) and Aluminum Strip Armor (ASA) but is also suitable for Single Wire Armor (SWA), Aluminum Wire Armor (AWA) and Pliable Wire Armor (PWA) if the range is outside that of the Stepped Cone (W). Grooved Cone (X) dimensions shown in the Cable Gland Selection Table below are for a double wire strand of braid armor cables. Tapes can also be doubled over. For cables that have only a single layer of armor such as SWA the clamping range should be used as shown in the table below. Stepped (W) Cone is suitable for Single Wire Armor (SWA), or Aluminum Wire Armor (AWA) cables.

Large table with columns: COMBINED ORDERING REFERENCE, AVAILABLE ENTRY THREADS, MINIMUM THREAD LENGTH, CABLE BEDDING DIAMETER, OVERALL CABLE DIAMETER, ARMOR RANGE (Grooved Cone X, Stepped Cone W), ACROSS FLATS, ACROSS CORNERS, PROTRUSION LENGTH, SHROUD, CABLE GLAND WEIGHT.

*Note : For material options please change the suffix in the ordering reference ; Brass (no suffix required), Nickel Plated Brass "5" (as standard), 316 Grade Stainless Steel "4", Copper Free Aluminum "1"
For NPT options please change the following digits after the material suffix ; 1/2" = 31, 3/4" = 32, 1" = 33, 1 1/4" = 34, 1 1/2" = 35, 2" = 36, 2 1/2" = 37, 3" = 38, 3 1/2" = 39, 4" = 310 (Brass requires prefix "0")
Examples: 32T3CDS1RA534 = Nickel Plated Brass 1 1/4" NPT, 25T3CDS1RA432 = Stainless Steel 3/4" NPT, 20T3CDS1RA5 = Nickel Plated Brass M20
Dimensions are displayed in inches unless otherwise stated

C2KX

C2KX GLOBALLY APPROVED, HAZARDOUS (CLASSIFIED) LOCATION CABLE GLAND

FOR ALL TYPES OF BRAIDED CABLES

- Metal-to-metal armor clamping
Direct and remote installation
Integral protected deluge seal
Controlled outer load retention seal
Unique OSTG prevents overtightening
Integral protected deluge seal
Standard:
-60°C to +130°C (-76°F to +266°F)
Globally marked, UL, cCSAus, IECEx, ATEX and UKEX



IP66 IP67 IP68 NEMA 4X
DELUGE PROTECTED EMC +266°F / -76°F
AEx e Ex e

Table with 2 columns: TECHNICAL CLASSIFICATION, GLOBAL PRODUCT CERTIFICATION. Includes design specification, mechanical classification, enclosure protection, electrical classification, ingress protection rating, NEMA rating, deluge protection compliance, cable type, armor clamping, seal material, sealing technique, and sealing area(s).

Table with 2 columns: GLOBAL PRODUCT CERTIFICATION. Includes ATEX certificate, UKEX certificate, code of protection, compliance standards, ECAS certificate, EAC certificate, code of protection, RETIE approval number, CCC certificate, SANS, and marine approvals.

* Mechanical and Electrical Classifications applied as per IEC 62444 and EN 62444 ** When CMP installation accessories are used. Refer to www.cmp-products.com for further information.
*** IP68 tested to a minimum depth of 30 metres for 12 hours, alternative depths / durations can be provided upon request

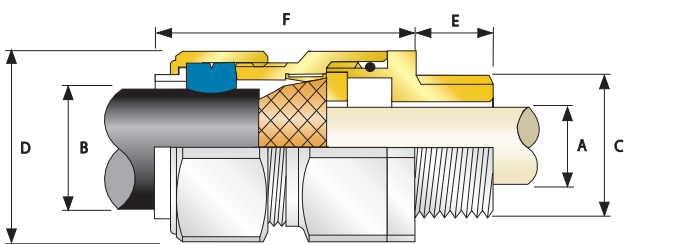

Large table with columns: COMBINED ORDERING REFERENCE, AVAILABLE ENTRY THREADS, MINIMUM THREAD LENGTH, CABLE BEDDING DIAMETER, OVERALL CABLE DIAMETER, ARMOR RANGE (Grooved Cone X), ACROSS FLATS, ACROSS CORNERS, PROTRUSION LENGTH, SHROUD, CABLE GLAND WEIGHT.

*Note : For material options please change the suffix in the ordering reference ; Brass (no suffix required), Nickel Plated Brass "5" (as standard), 316 Grade Stainless Steel "4", Copper Free Aluminum "1"
For NPT options please change the following digits after the material suffix ; 1/2" = 31, 3/4" = 32, 1" = 33, 1 1/4" = 34, 1 1/2" = 35, 2" = 36, 2 1/2" = 37, 3" = 38, 3 1/2" = 39, 4" = 310 (Brass requires prefix "0")
Examples: 32C2KX1RA5 = Nickel Plated Brass 32mm, 32C2KX1RA1 = Copper Free Aluminum 32mm
Dimensions are displayed in inches unless otherwise stated

PX2KX

PX2KX GLOBALLY APPROVED, HAZARDOUS (CLASSIFIED) LOCATION BARRIER CABLE GLAND

FOR ALL TYPES OF BRAIDED & TAPE ARMORED CABLES

- Metal-to-metal armor clamping
- Direct and remote installation
- Integral protected deluge seal
- Compound barrier type flameproof seal
- Controlled outer load retention seal
- Unique OSTG prevents overtightening
- Integral protected deluge seal
- Disconnectable, union feature design
- -60°C to +85°C (-76°F to +185°F)
- Globally marked, UL, cCSAus, IECEx, ATEX and UKEX
- Superior EMC performance
- As standard in nickel plated brass with NPT thread form
- Compound barrier seals around internal cable cores after removing any inner cable sheath/bedding; completely eliminating any risk of coldflow

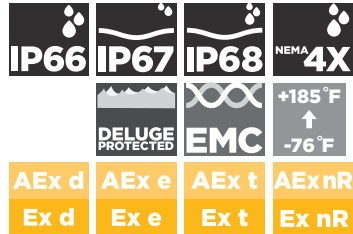
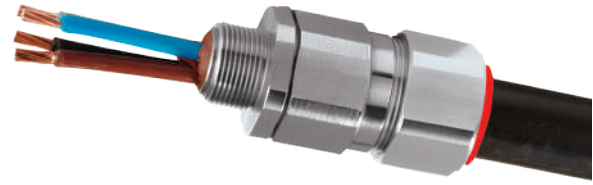

TECHNICAL CLASSIFICATION	
DESIGN SPECIFICATION	BS 6121:Part 1:1989, IEC 62444, EN 62444
MECHANICAL CLASSIFICATION*	Impact = Level 8, Cable Anchorage = Type B
ENCLOSURE PROTECTION	IK10 to IEC 62262 (20 joules) Brass and Stainless Steel only
ELECTRICAL CLASSIFICATION*	Category B (Category A when used with braid, tape or pliable wire armor cables)
INGRESS PROTECTION RATING**	IP66, IP67 and IP68****
NEMA RATING**	Type 4X
DELUGE PROTECTION COMPLIANCE	DTS01:91
CABLE GLAND MATERIAL	Electroless Nickel Plated Brass, Copper Free (<0.4%) Aluminum, Stainless Steel
SEAL MATERIAL	CMP SOLO LSF Halogen Free Thermostat Elastomer / Epoxy Barrier Compound
CABLE TYPE	Braid Armored Shipboard cable and all IEC Braid Cables***
ARMOR CLAMPING	Detachable Compound Tube / Cone and AnyWay Universal Clamping Ring
SEALING TECHNIQUE	CMP Outer Load Retention Seal
SEALING AREA(S)	Inner Compound Barrier and Outer Sheath

* Mechanical and Electrical Classifications applied as per IEC 62444 and EN 62444 ** When CMP installation accessories are used. Refer to www.cmp-products.com for further information. *** Where the cable is permitted by code (NEC and/or CEC) **** IP68 tested to a minimum depth of 30 metres for 12 hours, alternative depths / durations can be provided upon request.

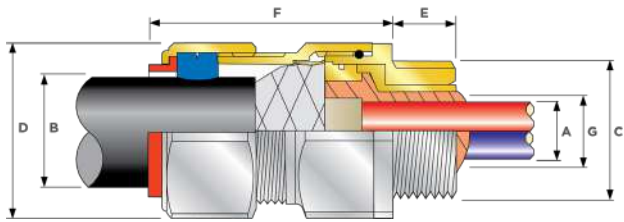

† Grooved Cone (X) is predominantly used for Wire Braid (e.g. GSWB, TCWB), Steel Tape Armour (STA, DSTA) and Aluminium Strip Armour (ASA) but is also suitable for Single Wire Armour (SWA), Aluminium Wire Armour (AWA) and Pliable Wire Armour (PWA) if the range is outside that of the Stepped Cone (W). Grooved Cone (X) dimensions shown in the Cable Gland Selection Table below are for a double wire strand of braid armour cables. Tapes can also be doubled over. For cables that have only a single layer of armour such as SWA the clamping range should be used as shown in the table below.

COMBINED ORDERING REFERENCE ("NICKEL PLATED BRASS NPT")			AVAILABLE ENTRY THREADS "C" (ALTERNATIVE METRIC THREAD LENGTHS AVAILABLE)				NUMBER OF CORES	DIAMETER OVER CONDUCTORS "A"	CABLE BEDDING DIAMETER "G"	OVERALL CABLE DIAMETER "B"		ARMOR RANGE† GROOVED CONE (X)		ACROSS FLATS "D"	ACROSS CORNERS "D"	PROTRUSION LENGTH "F"	SHROUD	APPROX WEIGHT ALUMINIUM (oz)
SIZE	TYPE	ORDERING SUFFIX	NPT (OPTION)	METRIC (OPTION)	THREAD LENGTH (NPT) "E"	MIN				MAX	MIN	MAX	MIN					
20S16	PX2KX	1RA531	1/2"	3/4"	M20	0.78	21	0.46	0.46	0.24	0.52	0.01	0.04	1.20	1.32	2.44	PVC06	8.47
20S	PX2KX	1RA531	1/2"	3/4"	M20	0.78	21	0.46	0.46	0.37	0.63	0.01	0.04	1.20	1.32	2.44	PVC06	8.11
20	PX2KX	1RA531	1/2"	3/4"	M20	0.78	21	0.50	0.51	0.49	0.82	0.02	0.04	1.20	1.32	2.48	PVC06	8.47
25S	PX2KX	1RA532	3/4"	1"	M25	0.80	30	0.69	0.70	0.55	0.87	0.02	0.05	1.48	1.62	2.74	PVC09	13.05
25	PX2KX	1RA532	3/4"	1"	M25	0.80	30	0.69	0.70	0.72	1.03	0.02	0.05	1.48	1.62	2.74	PVC09	13.05
32	PX2KX	1RA533	1"	1 1/4"	M32	0.98	38	0.93	0.94	0.93	1.34	0.02	0.05	1.81	1.99	2.95	PVC11	20.11
40	PX2KX	1RA534	1 1/4"	1 3/4"	M40	1.01	59	1.18	1.19	1.10	1.59	0.02	0.06	2.17	2.38	2.95	PVC15	28.22
50S	PX2KX	1RA535	1 1/2"	2"	M50	1.03	89	1.44	1.45	1.39	1.84	0.02	0.06	2.36	2.60	3.03	PVC18	31.75
50	PX2KX	1RA536	2"	2 1/2"	M50	1.06	115	1.61	1.63	1.59	2.09	0.02	0.06	2.76	3.04	3.03	PVC21	41.98
63S	PX2KX	1RA536	2"	2 1/2"	M63	1.06	115	1.89	1.88	1.80	2.34	0.02	0.06	2.95	3.25	3.14	PVC23	49.03
63	PX2KX	1RA537	2 1/2"	3"	M63	1.57	115	2.11	2.13	2.15	2.59	0.02	0.06	3.15	3.46	3.16	PVC25	49.74
75S	PX2KX	1RA537	2 1/2"	3"	M75	1.57	140	2.36	2.37	2.32	2.84	0.02	0.06	3.54	3.90	3.42	PVC28	73.72
75	PX2KX	1RA538	3"	3 1/2"	M75	1.63	140	2.53	2.54	2.63	3.09	0.02	0.06	3.94	4.33	3.48	PVC30	89.60
90	PX2KX	1RA539	3 1/2"	4"	M90	1.69	140	2.97	2.98	3.00	3.56	0.03	0.06	4.50	4.95	4.02	PVC32	130.87
100	PX2KX	1RA539	3 1/2"	4"	M100	1.69	200	3.29	3.29	3.39	3.99	0.03	0.06	5.24	5.76	4.49	LSF33	169.67

*Note: For material options please change the suffix in the ordering reference; Brass (no suffix required), Nickel Plated Brass "S" (as standard), 316 Grade Stainless Steel "4", Copper Free Aluminum "1" For NPT options please change the following digits after the material suffix; 1/2" = 31, 3/4" = 32, 1" = 33, 1 1/4" = 34, 1 1/2" = 35, 2" = 36, 2 1/2" = 37, 3" = 38, 3 1/2" = 39, 4" = 310 (Brass requires prefix "0")
Examples: 32PX2KX1RA534 = Nickel Plated Brass 1 1/4" NPT, 50SPX2KX1RA035 = Brass 1 1/2" NPT, 25PX2KX1RA432 = Stainless Steel 3/4" NPT, 20PX2KX1RA5 Nickel Plated Brass M20
Dimensions are displayed in inches unless otherwise stated

PX2KXREX RAPIDEx

PX2KXREX GLOBALLY APPROVED, HAZARDOUS (CLASSIFIED) LOCATION BARRIER CABLE GLAND

FOR ALL TYPES OF BRAIDED & TAPE ARMORED CABLES

- RapidEx liquid pour sealing system reduces installation time
- Metal-to-metal armor clamping
- Direct and remote installation
- Integral protected deluge seal
- Disconnectable, union feature design
- Controlled outer load retention seal
- Unique OSTG prevents overtightening
- -60°C to +85°C (-76°F to +185°F)
- Globally marked, UL, cCSAus, IECEx, ATEX and UKEX
- Superior EMC performance
- As standard in nickel plated brass with NPT thread form
- RapidEx liquid barrier resin seals around internal cable cores after removing any cable inner sheath/bedding; completely eliminating any risk of coldflow

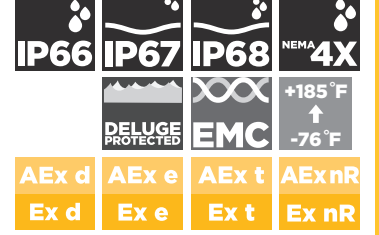
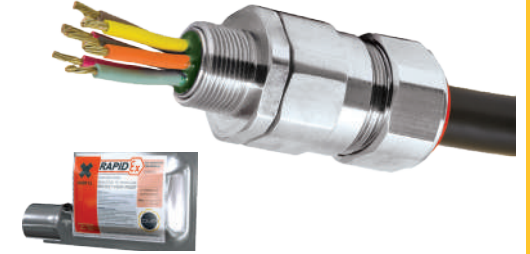

TECHNICAL CLASSIFICATION	
DESIGN SPECIFICATION	BS 6121:Part 1:1989, IEC 62444, EN 62444
MECHANICAL CLASSIFICATION*	Impact = Level 8, Cable Anchorage = Type B
ENCLOSURE PROTECTION	IK10 to IEC 62262 (20 joules) Brass & Stainless Steel only
ELECTRICAL CLASSIFICATION*	Category B (Category A when used with braid, tape or pliable wire armor cables)
INGRESS PROTECTION RATING**	IP66, IP67 & IP68****
NEMA TYPE RATING**	Type 4X
DELUGE PROTECTION COMPLIANCE	DTS01:91
CABLE TYPE	Braid Armored Shipboard cable and all IEC Braid Cables***
ARMOR CLAMPING	Detachable Resin Tube / Cone & AnyWay Universal Clamping Ring
SEAL MATERIAL	CMP SOLO LSF Halogen Free Thermostat Elastomer / RapidEx Resin Barrier
SEALING TECHNIQUE	CMP Outer Load Retention Seal and Inner RapidEx Barrier Seal
SEALING AREA(S)	Inner RapidEx Barrier Seal & Outer Sheath
CABLE GLAND MATERIAL	Electroless Nickel Plated Brass, Copper Free (<0.4%) Aluminum, Stainless Steel

* Mechanical and Electrical Classifications applied as per IEC 62444 and EN 62444 ** When CMP installation accessories are used. Refer to www.cmp-products.com for further information. *** Where the cable is permitted by code (NEC and/or CEC) **** IP68 tested to a minimum depth of 30 metres for 12 hours, alternative depths / durations can be provided upon request.

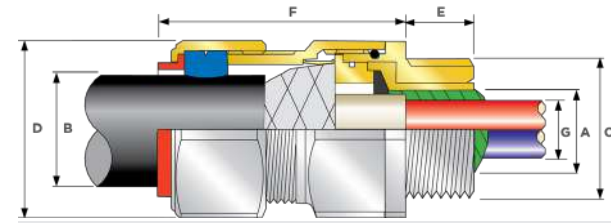

PATENT GRANTED: ES2287986, NO 2287986, TR 2287986, AU 2010284848, AU 2014274614, GB 2485114, SG 178839, US 8872027, US 9484133, US 9774178, MY 153843, US 10193321, US 1034078

GLOBAL PRODUCT CERTIFICATION			
ATEX CERTIFICATE	CML18ATEX1325X, CML18ATEX4317X	IECEx CERTIFICATE	IECEx CML 18.0182X
UKEX CERTIFICATE	CML 21UKEX1214X, CML 21UKEX4215X		
CODE OF PROTECTION	⊕ II 2G 1D, Ex db IIC Gb, Ex eb IIC Gb, Ex ta IIC Da ⊕ II 3G, Ex nR IIC Gc ⊕ I M2 Ex db I Mb*, Ex eb I Mb*	CODE OF PROTECTION	Ex db IIC Gb, Ex eb IIC Gb, Ex nR IIC Gc, Ex ta IIC Da, Ex eb I Mb*, Ex eb I Mb*
COMPLIANCE STANDARDS	EN 60079-0,1,7,15,31	COMPLIANCE STANDARDS	IEC 60079-0,1,7,15,31
cSAus CERTIFICATE (20S16-90)	2288626		
CSAus CODE OF PROTECTION**	Class I, Div 1 and 2, Groups A, B, C, and D; Class II, Div 1 and 2, Groups E, F, and G; Class III, Div 1 and 2; Type 4X; Oil Resistance II; Class I, Zone 1, AEx d IIC Gb, AEx e IIC Gb; Class I, Zone 2, AEx nR IIC Gc; Class I, Zone 20, AEx ta IIC Da		
cSA CODE OF PROTECTION**	Class I, Div 1 and 2, Groups A, B, C, and D; Class II, Div 1 and 2, Groups E, F, and G; Class III, Div 1 and 2; Type 4X; Oil Resistance II; Ex d IIC Gb, Ex e IIC Gb, Ex nR IIC Gc, Ex ta IIC Da		
COMPLIANCE STANDARDS	CAN/CSA-C22.2 No 0, 18, 25, 30, 174, 94, CAN/CSA-C22.2 No 60079-1,7,15,31, CAN/CSA-E61241-1-1, ANSI/UL 514B, 50, 2225, ANSI/ISA 60079-31, UL60079-0,1,7,15		
ECAS CERTIFICATE	20-02-05624	UkrSEPRO CERTIFICATE	CU 19.0371X
EAC CERTIFICATE	TC RU C-GB.A07.B.04595/22		
CODE OF PROTECTION	1Ex d IIC Gb X, 1Ex e IIC Gb X, 2Ex nR IIC Gc X, Ex ta IIC Da X, IP66, IP67, IP68		
RETIE APPROVAL NUMBER	03866	CCOE / PESO (INDIA) CERTIFICATE	P548696, P533772, P548695
CCC CERTIFICATE	2020322313003190	INMETRO APPROVAL	TUV 12.2073X
MARINE APPROVALS	LRS: LR22320739TA, DNV: TAE000000Y, ABS: 20-LD1948801-PDA, BV: 43180		

*Aluminium alloys are not permitted in Group I mining applications
**Where the cable is permitted by code (NEC and/or CEC)



† Grooved Cone (X) is predominantly used for Wire Braid (e.g. GSWB, TCWB), Steel Tape Armour (STA, DSTA) and Aluminium Strip Armour (ASA) but is also suitable for Single Wire Armour (SWA), Aluminium Wire Armour (AWA) and Pliable Wire Armour (PWA) if the range is outside that of the Stepped Cone (W). Grooved Cone (X) dimensions shown in the Cable Gland Selection Table below are for a double wire strand of braid armour cables. Tapes can also be doubled over. For cables that have only a single layer of armour such as SWA the clamping range should be used as shown in the table below.

COMBINED ORDERING REFERENCE ("NICKEL PLATED BRASS NPT")			AVAILABLE ENTRY THREADS "C" (ALTERNATIVE METRIC THREAD LENGTHS AVAILABLE)				NUMBER OF CORES	DIAMETER OVER CONDUCTORS "A"	CABLE BEDDING DIAMETER "G"	OVERALL CABLE DIAMETER "B"		ARMOR RANGE † GROOVED CONE (X)		ACROSS FLATS "D"	ACROSS CORNERS "D"	PROTRUSION LENGTH "F"	SHROUD	APPROX WEIGHT ALUMINIUM (oz)
SIZE	TYPE	ORDERING SUFFIX	NPT (OPTION)	METRIC (OPTION)	THREAD LENGTH (NPT) "E"	MIN				MAX	MIN	MAX	MIN					
20S16	PX2KXREX	1EX531	1/2"	3/4"	M20	0.78	21	0.46	0.46	0.24	0.52	0.01	0.04	1.20	1.32	2.44	PVC06	8.47
20S	PX2KXREX	1EX531	1/2"	3/4"	M20	0.78	21	0.46	0.46	0.37	0.63	0.01	0.04	1.20	1.32	2.44	PVC06	8.11
20	PX2KXREX	1EX531	1/2"	3/4"	M20	0.78	21	0.50	0.51	0.49	0.82	0.02	0.04	1.20	1.32	2.48	PVC06	8.47
25S	PX2KXREX	1EX532	3/4"	1"	M25	0.80	30	0.69	0.70	0.55	0.87	0.02	0.05	1.48	1.62	2.74	PVC09	13.05
25	PX2KXREX	1EX532	3/4"	1"	M25	0.80	30	0.69	0.70	0.72	1.03	0.02	0.05	1.48	1.62	2.74	PVC09	13.05
32	PX2KXREX	1EX533	1"	1 1/4"	M32	0.98	59	0.93	0.94	0.93	1.34	0.02	0.05	1.81	1.99	2.95	PVC11	20.11
40	PX2KXREX	1EX533	1"	1 1/4"	M32	0.98	59	0.93	0.94	0.93	1.34	0.02	0.05	1.81	1.99	2.95	PVC11	20.11
50S	PX2KXREX	1EX534	1 1/2"	2"	M40	1.01	59	1.18	1.19	1.10	1.59	0.02	0.06	2.17	2.38	2.95	PVC15	28.22
50	PX2KXREX	1EX535	1 1/2"	2"	M50	1.03	89	1.44	1.45	1.39	1.84	0.02	0.06	2.36	2.60	3.03	PVC18	31.75
63S	PX2KXREX	1EX536	2"	2 1/2"	M50	1.06	115	1.61	1.63	1.59	2.09	0.02	0.06	2.76	3.04	3.03	PVC21	41.98
63	PX2KXREX	1EX536	2"	2 1/2"	M63	1.06	115	1.89	1.91	1.80	2.34	0.02	0.06	2.95	3.25	3.14	PVC23	49.03
75S	PX2KXREX	1EX537	2 1/2"	3"	M63	1.57	115	2.11	2.13	2.15	2.59	0.02	0.06	3.15	3.46	3.16	PVC25	49.74
75	PX2KXREX	1EX537	2 1/2"	3"	M75	1.57	140	2.36	2.37	2.32	2.84	0.02	0.06	3.54	3.90	3.42	PVC28	73.72
90	PX2KXREX	1EX538	3"	3 1/2"	M75	1.63	140	2.53	2.54	2.63	3.09	0.02	0.06	3.94	4.33	3.48	PVC30	89.60
90	PX2KXREX	1EX539	3 1/2"	4"	M90	1.69	140	2.97	2.98	3.00	3.56	0.03	0.06	4.50	4.95	4.02	PVC32	130.87
100	PX2KXREX	1EX539	3 1/2"	4"	M100	1.69	200	3.29	3.29	3.39	3.99	0.03	0.06	5.24	5.76	4.49	LSF33	169.67

*Note: For material options please change the suffix in the ordering reference; Brass (no suffix required), Nickel Plated Brass "S" (as standard), 316 Grade Stainless Steel "4", Copper Free Aluminum "1" For NPT options please change the following digits after the material suffix; 1/2" = 31, 3/4" = 32, 1" = 33, 1 1/4" = 34, 1 1/2" = 35, 2" = 36, 2 1/2" = 37, 3" = 38, 3 1/2" = 39, 4" = 310 (Brass requires prefix "0")
Examples: 32PX2KXREX1EX534 = Nickel Plated Brass 1 1/4" NPT, 25PX2KXREX1EX432 = Stainless Steel 3/4" NPT, 20PX2KXREX1EX5 Nickel Plated Brass M20
Dimensions are displayed in inches unless otherwise stated

PX2KW

PX2KW GLOBALLY APPROVED, HAZARDOUS (CLASSIFIED) LOCATION BARRIER CABLE GLAND

FOR ALL TYPES OF SINGLE / SERVED WIRE ARMORED CABLES

- Metal-to-metal armor clamping
- Direct and remote installation
- Integral protected deluge seal
- Compound barrier type flameproof seal
- Controlled outer load retention seal
- Unique OSTG prevents overtightening
- Disconnectable, union feature design
- -60°C to +85°C (-76°F to +185°F)
- Globally marked, UL, cCSAus, IECEx, ATEX and UKEX
- Superior EMC performance
- As standard in nickel plated brass with NPT thread form
- Compound barrier seals around internal cable cores after removing any inner cable sheath/bedding; completely eliminating any risk of coldflow

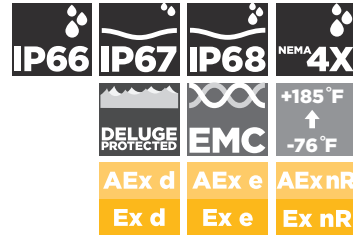
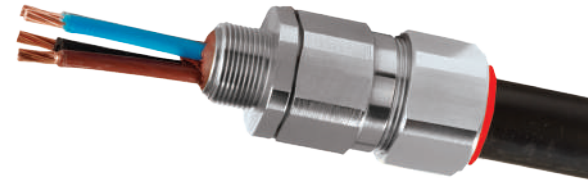

TECHNICAL CLASSIFICATION	
DESIGN SPECIFICATION	BS 6121:Part 1:1989, IEC 62444, EN 62444
MECHANICAL CLASSIFICATION*	Impact = Level 8, Cable Anchorage = Type D
ENCLOSURE PROTECTION	IK10 to IEC 62262 (20 joules) Brass and Stainless Steel only
ELECTRICAL CLASSIFICATION*	Category B
INGRESS PROTECTION RATING**	IP66, IP67 and IP68****
NEMA RATING**	Type 4X
DELUGE PROTECTION COMPLIANCE	DTS01 : 91
CABLE GLAND MATERIAL	Electroless Nickel Plated Brass, Copper Free (<0.4%) Aluminum, Stainless Steel
SEAL MATERIAL	CMP SOLO LSF Halogen Free Thermostat Elastomer / Epoxy Barrier Compound
CABLE TYPE	Single / Served Wire Armor (SWA)***
ARMOR CLAMPING	Detachable Compound Tube / Cone and AnyWay Universal Clamping Ring
SEALING TECHNIQUE	CMP Outer Load Retention Seal
SEALING AREA(S)	Inner Compound Barrier and Outer Sheath

* Mechanical and Electrical Classifications applied as per IEC 62444 and EN 62444 ** When CMP installation accessories are used. Refer to www.cmp-products.com for further information.
 Where the cable is permitted by code (NEC and/or CEC) * IP68 tested to a minimum depth of 30 metres for 12 hours, alternative depths / durations can be provided upon request

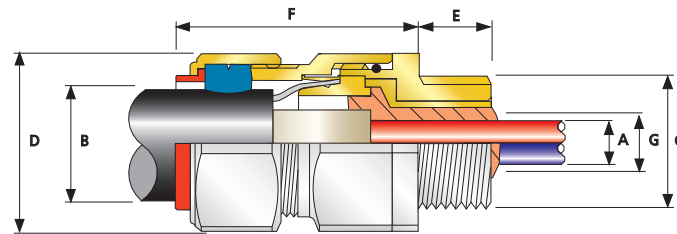

COMBINED ORDERING REFERENCE (*NICKEL PLATED BRASS NPT)			AVAILABLE ENTRY THREADS *C (ALTERNATIVE METRIC THREAD LENGTHS AVAILABLE)				NUMBER OF CORES	DIAMETER OVER CONDUCTORS *A		CABLE BEDDING DIAMETER *G		OVERALL CABLE DIAMETER *B		ARMOR RANGE		ACROSS FLATS *D		ACROSS CORNERS *D		PROTRUSION LENGTH *F	SHROUD	CABLE GLAND WEIGHT (oz)
SIZE	TYPE	ORDERING SUFFIX	NPT	NPT (OPTION)	METRIC (OPTION)	THREAD LENGTH (NPT) *E		MAX	MIN	MAX	MIN	MAX	MIN	MAX	MIN	MAX	MIN	MAX				
20S16	PX2KW	1RA531	1/2"	3/4"	M20	0.78	21	0.46	0.46	0.24	0.52	0.03	0.05	1.20	1.32	2.44	PVC06	8.47				
20S	PX2KW	1RA531	1/2"	3/4"	M20	0.78	21	0.46	0.46	0.37	0.63	0.03	0.05	1.20	1.32	2.44	PVC06	8.11				
20	PX2KW	1RA531	1/2"	3/4"	M20	0.78	21	0.50	0.51	0.49	0.82	0.03	0.05	1.20	1.32	2.48	PVC06	8.47				
25S	PX2KW	1RA532	3/4"	1"	M25	0.80	30	0.69	0.70	0.55	0.87	0.05	0.06	1.48	1.62	2.74	PVC09	13.05				
25	PX2KW	1RA532	3/4"	1"	M25	0.80	30	0.69	0.70	0.72	1.03	0.05	0.06	1.48	1.62	2.74	PVC09	13.05				
32	PX2KW	1RA533	1"	1 1/4"	M32	0.98	38	0.93	0.94	0.93	1.34	0.06	0.08	1.81	1.99	2.95	PVC11	20.11				
40	PX2KW	1RA534	1 1/4"	1 1/2"	M40	1.01	59	1.18	1.19	1.10	1.59	0.06	0.08	2.17	2.38	2.95	PVC15	28.22				
50S	PX2KW	1RA535	1 1/2"	2"	M50	1.03	89	1.44	1.45	1.39	1.84	0.08	0.10	2.36	2.60	3.03	PVC18	31.75				
50	PX2KW	1RA536	2"	2 1/2"	M50	1.06	115	1.61	1.63	1.59	2.09	0.08	0.10	2.76	3.04	3.03	PVC21	41.98				
63S	PX2KW	1RA536	2"	2 1/2"	M63	1.06	115	1.89	1.91	1.80	2.34	0.08	0.10	2.95	3.25	3.14	PVC23	49.03				
63	PX2KW	1RA537	2 1/2"	3"	M63	1.57	115	2.11	2.13	2.15	2.59	0.08	0.10	3.15	3.46	3.16	PVC25	49.74				
75S	PX2KW	1RA537	2 1/2"	3"	M75	1.57	140	2.36	2.37	2.32	2.84	0.08	0.10	3.54	3.90	3.42	PVC28	73.72				
75	PX2KW	1RA538	3"	3 1/2"	M75	1.63	140	2.53	2.54	2.63	3.09	0.10	0.12	3.94	4.33	3.48	PVC30	89.60				
90	PX2KW	1RA539	3 1/2"	4"	M90	1.69	140	2.97	2.98	3.00	3.56	0.12	0.16	4.50	4.95	4.02	PVC32	130.87				
100	PX2KW	1RA539	3 1/2"	4"	M100	1.69	200	3.29	3.38	3.39	3.99	0.12	0.16	5.24	5.76	4.49	LSF33	169.67				

*Note : For material options please change the suffix in the ordering reference ; Brass (no suffix required), Nickel Plated Brass "5" (as standard), 316 Grade Stainless Steel "4", Copper Free Aluminum "1"
 For NPT options please change the following digits after the material suffix ; 1/2" = 31, 3/4" = 32, 1" = 33, 1 1/4" = 34, 1 1/2" = 35, 2" = 36, 2 1/2" = 37, 3" = 38, 3 1/2" = 39, 4" = 310 (Brass requires prefix "0")
 Examples: 32PX2KW1RA534 = Nickel Plated Brass 1 1/4" NPT, 25PX2KW1RA432 = Stainless Steel 3/4" NPT, 20PX2KW1RA5 Nickel Plated Brass M20
 Dimensions are displayed in inches unless otherwise stated

PX2KWREX

PX2KWREX GLOBALLY APPROVED, HAZARDOUS (CLASSIFIED) LOCATION BARRIER CABLE GLAND

FOR ALL TYPES OF SINGLE / SERVED WIRE ARMORED CABLES

- RapidEx liquid pour sealing system reduces installation time
- Metal-to-metal armor clamping
- Direct and remote installation
- Integral protected deluge seal
- Disconnectable, union feature design
- Controlled outer load retention seal
- Unique OSTG prevents overtightening
- -60°C to +85°C (-76°F to +185°F)
- Globally marked, UL, cCSAus, IECEx, ATEX and UKEX
- Superior EMC performance
- As standard in nickel plated brass with NPT thread form
- RapidEx liquid barrier resin seals around internal cable cores after removing any cable inner sheath/bedding; completely eliminating any risk of coldflow

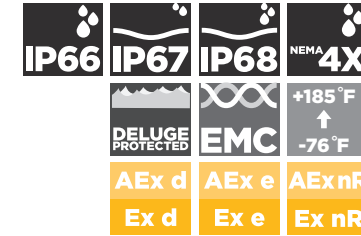

TECHNICAL CLASSIFICATION	
DESIGN SPECIFICATION	BS 6121:Part 1:1989, IEC 62444, EN 62444
MECHANICAL CLASSIFICATION*	Impact = Level 8, Cable Anchorage = Type D
ENCLOSURE PROTECTION	IK10 to IEC 62262 (20 joules) Brass and Stainless Steel only
ELECTRICAL CLASSIFICATION*	Category B
INGRESS PROTECTION RATING**	IP66, IP67 and IP68****
NEMA RATING**	Type 4X
DELUGE PROTECTION COMPLIANCE	DTS01 : 91
CABLE TYPE	Single / Served Wire Armor (SWA)***
ARMOR CLAMPING	Detachable Resin Tube / Cone and AnyWay Universal Clamping Ring
SEAL MATERIAL	CMP SOLO LSF Halogen Free Thermostat Elastomer / RapidEx Resin Barrier
SEALING TECHNIQUE	CMP Outer Load Retention Seal and Inner RapidEx Barrier Seal
SEALING AREA(S)	Inner RapidEx Barrier Seal and Outer Sheath
CABLE GLAND MATERIAL	Electroless Nickel Plated Brass, Copper Free (<0.4%) Aluminum, Stainless Steel

* Mechanical and Electrical Classifications applied as per IEC 62444 and EN 62444 ** When CMP installation accessories are used. Refer to www.cmp-products.com for further information.
 Where the cable is permitted by code (NEC and/or CEC) * IP68 tested to a minimum depth of 30 metres for 12 hours, alternative depths / durations can be provided upon request

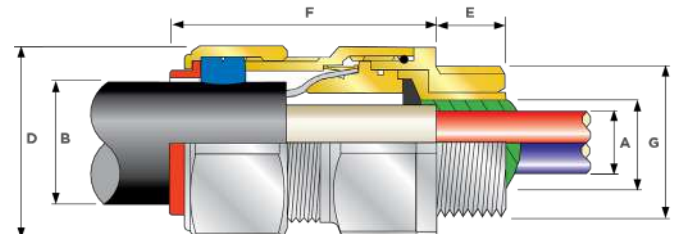

COMBINED ORDERING REFERENCE (*NICKEL PLATED BRASS NPT)			AVAILABLE ENTRY THREADS *C (ALTERNATIVE METRIC THREAD LENGTHS AVAILABLE)				NUMBER OF CORES	DIAMETER OVER CONDUCTORS *A		CABLE BEDDING DIAMETER *G		OVERALL CABLE DIAMETER *B		ARMOR RANGE		ACROSS FLATS *D		ACROSS CORNERS *D		PROTRUSION LENGTH *F	SHROUD	APPROX WEIGHT ALUMINIUM (oz)
SIZE	TYPE	ORDERING SUFFIX	NPT	NPT (OPTION)	METRIC (OPTION)	THREAD LENGTH (NPT) *E		MAX	MIN	MAX	MIN	MAX	MIN	MAX	MIN	MAX	MIN	MAX				
20S16	PX2KWREX	1EX531	1/2"	3/4"	M20	0.78	21	0.46	0.46	0.24	0.52	0.03	0.05	1.20	1.32	2.44	PVC06	8.47				
20S	PX2KWREX	1EX531	1/2"	3/4"	M20	0.78	21	0.46	0.46	0.37	0.63	0.03	0.05	1.20	1.32	2.44	PVC06	8.11				
20	PX2KWREX	1EX531	1/2"	3/4"	M20	0.78	21	0.50	0.51	0.49	0.82	0.03	0.05	1.20	1.32	2.48	PVC06	8.47				
25S	PX2KWREX	1EX532	3/4"	1"	M25	0.80	30	0.69	0.70	0.55	0.87	0.05	0.06	1.48	1.62	2.74	PVC09	13.05				
25	PX2KWREX	1EX532	3/4"	1"	M25	0.80	30	0.69	0.70	0.72	1.03	0.05	0.06	1.48	1.62	2.74	PVC09	13.05				
32	PX2KWREX	1EX533	1"	1 1/4"	M32	0.98	50	0.93	0.94	0.93	1.34	0.06	0.08	1.81	1.99	2.95	PVC11	20.11				
40	PX2KWREX	1EX534	1 1/4"	1 1/2"	M40	1.01	59	1.18	1.19	1.10	1.59	0.06	0.08	2.17	2.38	2.95	PVC15	28.22				
50S	PX2KWREX	1EX535	1 1/2"	2"	M50	1.03	89	1.44	1.45	1.39	1.84	0.08	0.10	2.36	2.60	3.03	PVC18	31.75				
50	PX2KWREX	1EX536	2"	2 1/2"	M50	1.06	115	1.61	1.63	1.59	2.09	0.08	0.10	2.76	3.04	3.03	PVC21	41.98				
63S	PX2KWREX	1EX536	2"	2 1/2"	M63	1.06	115	1.89	1.90	1.80	2.34	0.08	0.10	2.95	3.25	3.14	PVC23	49.03				
63	PX2KWREX	1EX537	2 1/2"	3"	M63	1.57	115	2.11	2.13	2.15	2.59	0.08	0.10	3.15	3.46	3.16	PVC25	49.74				
75S	PX2KWREX	1EX537	2 1/2"	3"	M75	1.57	140	2.36	2.37	2.32	2.84	0.08	0.10	3.54	3.90	3.42	PVC28	73.72				
75	PX2KWREX	1EX538	3"	3 1/2"	M75	1.63	140	2.53	2.54	2.63	3.09	0.10	0.12	3.94	4.33	3.48	PVC30	89.60				
90	PX2KWREX	1EX539	3 1/2"	4"	M90	1.69	140	2.97	2.98	3.00	3.56	0.12	0.16	4.50	4.95	4.02	PVC32	130.87				
100	PX2KWREX	1EX539	3 1/2"	4"	M100	1.69	200	3.29	3.30	3.39	3.99	0.12	0.16	5.24	5.76	4.49	LSF33	169.67				

*Note : For material options please change the suffix in the ordering reference ; Brass (no suffix required), Nickel Plated Brass "5" (as standard), 316 Grade Stainless Steel "4", Copper Free Aluminum "1"
 For NPT options please change the following digits after the material suffix ; 1/2" = 31, 3/4" = 32, 1" = 33, 1 1/4" = 34, 1 1/2" = 35, 2" = 36, 2 1/2" = 37, 3" = 38, 3 1/2" = 39, 4" = 310 (Brass requires prefix "0")
 Examples: 32PX2KWREX1EX534 = Nickel Plated Brass 1 1/4" NPT, 25PX2KWREX1EX432 = Stainless Steel 3/4" NPT, 20PX2KWREX1EX5 Nickel Plated Brass M20
 Dimensions are displayed in inches unless otherwise stated

ORDERING ACCESSORIES

When selecting and installing certified electrical equipment and components in potentially Explosive Atmospheres, it is the users responsibility to ensure that the local industry codes of practice are observed and followed, for example IEC 60079-14.

To determine ordering reference please select from the tables below in the following order:



EXAMPLE 1. 737DT3T25
737 Adaptor - Globally Certified - 1" (M) x 3/4" (F) - Nickel Plated Brass

PRODUCT TYPE	FORM OF PROTECTION	OPTION	MALE THREAD FORM	MALE THREAD SIZE	FEMALE THREAD FORM	FEMALE THREAD SIZE	MATERIAL
From Product Page	From Table A Below	From Table B Below	From Table C Below	From Table D Below	From Table C Below	From Table D Below	From Table E Below
737	D	R	T	3	T	2	5

EXAMPLE 2. 747DAT15
747 Recessed Stopper Plug - Globally Certified - 1/2" - Nickel Plated Brass

PRODUCT TYPE	FORM OF PROTECTION	OPTION	MALE THREAD FORM	MALE THREAD SIZE	MATERIAL
From Product Page	From Table A Below	From Table B Below	From Table C Below	From Table D Below	From Table E Below
747	D	A	T	1	5

TABLE A

CODE	FORM OF PROTECTION
D	Group II Globally Certified Ex d / AEx d & Ex e / AEx e
E	Group II Increased Safety Ex e / AEx e
G	General Purpose
M	Group I Mining

TABLE B

CODE	OPTIONS
A	Type A e.g. externally secured - Non tamper-proof Ex d Stopper Plug
B	Type B e.g. internally secured - tamper-proof Ex d Stopper Plug
R	Optional equipment interface 'O' ring seal

Type 'A' and 'B' for stopper plugs and insulated adaptors only

TABLE C

CODE	THREAD FORM
M	Metric
N	NPSM
T	NPT
P	PG
B	BSPP
I	E.T. (Imperial)
S	BSPT

Other variations available on request

Nominal dimensions shown in this catalog may vary due to material availability. All dimensions shown are in inches unless otherwise stated. Within the parameters of its Explosive Atmosphere certification, CMP Products reserves the right to change the design and/or dimensions of any of the products illustrated without notice. For further information please contact CMP Products.

TABLE D

CODE	THREAD SIZE						
	METRIC "M"	NPSM "N"	NPT "T"	PG "P"	BSPP "B"	IMPERIAL "I"	BSPT "S"
1A	-	-	-	7	-	-	-
1	16	1/2"	1/2"	9	1/2"	5/8"	1/2"
2	20	3/4"	3/4"	11	3/4"	3/4"	3/4"
3	25	1"	1"	13.5	1"	1"	1"
4	32	1-1/4"	1-1/4"	16	1-1/4"	1-1/4"	1-1/4"
5	40	1-1/2"	1-1/2"	21	1-1/2"	1-1/2"	1-1/2"
6	50	2"	2"	29	2"	2"	2"
7	63	2-1/2"	2-1/2"	36	2-1/2"	2-1/2"	2-1/2"
8	75	3"	3"	42	3"	3"	3"
9	90	3 1/2"	3 1/2"	48	3-1/2"	3-1/2"	3 1/2"
10	100	4"	4"	-	4"	4"	4"

Other thread sizes available upon request

TABLE E

CODE	MATERIAL
1	Aluminum
2	Nylon
4	Stainless Steel 316
5	Nickel Plated Brass

737 AEx e Ex e AEx d Ex d AEx t Ex t

ADAPTORS & REDUCERS

- Used for thread conversion
 - Virtually any thread type can be supplied
 - Wide range of thread types & sizes
 - General purpose / industrial version available
 - Equipment interface 'O' ring seal available
 - 76°F to 392°F (metallic versions)
- Globally marked, IECEx, ATEX, UL & cCSAus



DESIGN SPECIFICATION	BS 6121:Part 1:1989
ENCLOSURE PROTECTION	IK10 to IEC 62262 (20 joules) Brass & Stainless Steel Only
ATEX CERTIFICATE	CML 18ATEX1320X
CODE OF PROTECTION	Ⓢ II 2G Ex db IIC Gb, Ex eb IIC Gb, II TD Ex ta IIIC Da Ⓢ IM2 Ex db I Mb, Ex eb I Mb (II 2G Ex eb IIC Gb, II TD Ex ta IIIC Da only on Nylon version)
IECEx CERTIFICATE	IECEx CML 18.0177X
CODE OF PROTECTION	Ex db I Mb, Ex eb I Mb, Ex db IIC Gb, Ex eb IIC Gb, Ex ta IIIC Da (Ex eb IIC Gb, Ex ta IIIC Da only on nylon version)
cCSAus CERTIFICATE	1055233
CODE OF PROTECTION	Class I, Groups A, B, C and D; IP66, 67, 68; Enclosure Type 4X; Class II groups E, F and G; Class III, Ex de II, Class I, Zone 1, AEx de II; (Not available in Nylon)
UL CERTIFICATE	E214221 (Reducers with NPT or Metric Threads only)
CODE OF PROTECTION	Class I Groups A,B,C,D; Class II Groups E,F,G; Class III

EXAMPLE ORDERING REFERENCE	MALE THREAD SIZE	FEMALE THREAD SIZE
737DM2M35	M20 X 1.5	M25 X 1.5
737DM3M45	M25 X 1.5	M32 X 1.5
737DM3M25	M25 X 1.5	M20 X 1.5
737DM4M35	M32 X 1.5	M25 X 1.5
737DT1M25	NPT 1/2"	M20 X 1.5
737DT2M35	NPT 3/4"	M25 X 1.5
737DM2T15	M20 X 1.5	1/2"
737DT1T25	1/2"	3/4"

Dimensions are displayed in inches unless otherwise stated. Alternative threads available.

787 AEx e Ex e AEx d Ex d AEx t Ex t

90° ADAPTORS

- Protects cables from excessive bending stress
 - General purpose / industrial version available
 - Supplied with male or female threads
 - Can be supplied with thread conversion
 - Equipment interface 'O' ring seal available
 - 76°F to 392°F
- Globally marked, IECEx, ATEX & cCSAus



DESIGN SPECIFICATION	BS 6121:Part 1:1989
ENCLOSURE PROTECTION	IK10 to IEC 62262 (20 joules) Brass & Stainless Steel Only
ATEX CERTIFICATE	CML 18ATEX1319U
CODE OF PROTECTION	Ⓢ II 2 G Ex db IIC Gb, Ex eb IIC Gb, II TD Ex ta IIIC Da Ⓢ IM2 Ex db I Mb, Ex eb I Mb
IECEx CERTIFICATE	IECEx CML 18.0176U
CODE OF PROTECTION	Ex db I Mb / Ex eb I Mb / Ex db IIC Gb / Ex eb IIC Gb / Ex ta IIIC Da
cCSAus CERTIFICATE	1055233
CODE OF PROTECTION	Class I, Groups A, B, C and D; IP66, 67, 68; Enclosure Type 4X; Ex de II, Class I, Zone 1, AEx de II;

EXAMPLE ORDERING REFERENCE	MALE THREAD SIZE	FEMALE THREAD SIZE
787DM2M25	M20 X 1.5	M20 X 1.5
787DM3M35	M25 X 1.5	M25 X 1.5
787DM4M45	M32 X 1.5	M32 X 1.5
787DM5M55	M40 X 1.5	M40 X 1.5
787DT1T15	1/2"	1/2"
787DT2T25	3/4"	3/4"
787DT1M25	1/2"	M20 X 1.5
787DT2M35	3/4"	M25 X 1.5

Dimensions are displayed in inches unless otherwise stated. Alternative threads available.

777 AEx e Ex e AEx d Ex d AEx t Ex t

INSULATED ADAPTORS

- Isolates metallic cable glands from equipment
 - Essential in areas of high electromagnetic noise
 - Particularly relevant in power plants
 - General purpose / industrial version available
 - Can be supplied with thread conversion
 - 76°F to 266°F
- Globally marked, IECEx, ATEX & cCSAus



DESIGN SPECIFICATION	BS 6121:Part 1:1989
ENCLOSURE PROTECTION	IK10 to IEC 62262 (20 joules) Brass & Stainless Steel Only
ATEX CERTIFICATE	CML 18ATEX1328U
CODE OF PROTECTION	Ⓢ II 2G1D Ex db IIC Gb / Ex eb IIC Gb / Ex ta IIIC Da
IECEx CERTIFICATE	IECEx CML 18.0185U
CODE OF PROTECTION	Ex db IIC Gb / Ex eb IIC Gb / Ex ta IIIC Da
cCSAus CERTIFICATE	1055233
CODE OF PROTECTION	Class I, Groups A, B, C and D; IP66, 67, 68; Enclosure Type 4X; DIP A; Ex de II, Class I, Zone 1, AEx de II;

EXAMPLE ORDERING REFERENCE	NPT MALE THREAD SIZE	NPT FEMALE THREAD SIZE
777DAT1T15	1/2"	1/2"
777DAT2T25	3/4"	3/4"
777DAT3T35	1"	1"
777DAT4T45	1 1/4"	1 1/4"
777DAT5T55	1 1/2"	1 1/2"
777DAT6T65	2"	2"
777DAT7T75	2 1/2"	2 1/2"
777DAT8T85	3"	3"

Dimensions are displayed in inches unless otherwise stated. Alternative threads available.

797 AEx e Ex e AEx d Ex d AEx t Ex t

MALE-MALE & FEMALE-FEMALE ADAPTORS

- Designed to convert existing threads
 - General purpose / industrial version available
 - Supplied with male or female threads
 - Can be supplied with thread conversion
 - 76°F to 392°F
- Globally marked, IECEx, ATEX & cCSAus



DESIGN SPECIFICATION	BS 6121:Part 1:1989
ENCLOSURE PROTECTION	IK10 to IEC 62262 (20 joules) Brass & Stainless Steel Only
ATEX CERTIFICATE	CML 18ATEX1320X
CODE OF PROTECTION	Ⓢ II 2 G Ex db IIC Gb, Ex eb IIC Gb, II TD Ex ta IIIC Da Ⓢ IM2 Ex db I Mb, Ex eb I Mb
IECEx CERTIFICATE	IECEx CML 18.0177X
CODE OF PROTECTION	Ex db I Mb / Ex eb I Mb / Ex db IIC Gb / Ex eb IIC Gb / Ex ta IIIC Da
cCSAus CERTIFICATE	1055233
CODE OF PROTECTION	Ex de II; Class I, Groups A, B, C and D; Class I, Zone 1, AEx de II; IP66, 67, and 68, Enclosure Type 4X.

EXAMPLE ORDERING REFERENCE	MALE FORWARD THREAD	MALE REAR THREAD
797DM1M1M5	M16 X 1.5	M16 X 1.5
797DM3M3M5	M25 X 1.5	M25 X 1.5
797DM4M4M5	M32 X 1.5	M32 X 1.5
797DT1M1M5	1/2"	1/2"
797DT2M2M5	3/4"	3/4"
797DT3M3M5	1"	1"
797DM2M1M5	M20 X 1.5	1/2"
797DM2M2M5	M20 X 1.5	3/4"
797DM3M2M5	M25 X 1.5	3/4"

Dimensions are displayed in inches unless otherwise stated. Alternative threads available.

780

AEEx e Ex e AEEx d Ex d AEEx t Ex t

IN-LINE UNIONS

- Allows the connection of conduit or glands to equipment
- Suitable for rigid or flexible conduit
- Eliminates the need to rotate the conduit
- Equipment interface 'O' ring seal available
- 76°F to 392°F
- Globally marked, IECEX, ATEX & cCSAus



DESIGN SPECIFICATION	BS 6121:Part 1:1989
ENCLOSURE PROTECTION	IK10 to IEC 62262 (20 joules) Brass & Stainless Steel only
ATEX CERTIFICATE	CML 18ATEX1329U
CODE OF PROTECTION	Ⓜ II 2G ID Ex db IIC Gb, Ex eb IIC Gb, Ex ta IIIC Da IP6X Ⓜ IM2 Ex db I Mb / Ex eb I Mb
IECEX CERTIFICATE	IECEX CML 18.0186U
CODE OF PROTECTION	Ex db IIC Gb, Ex eb IIC Gb, Ex ta IIIC Da IP6X, Ex db I Mb, Ex eb I Mb
cCSAus CERTIFICATE	1055233
CODE OF PROTECTION	Class I, Div 1 & 2, Groups A,B,C,D ; Enclosure type 4X : Class I, Zone 1, AEx de II ; Ex de II

EXAMPLE ORDERING REFERENCE	FIRST THREAD SIZE	SECOND THREAD SIZE
780DM2M25	M20 X 1.5	M20 X 1.5
780DM3M35	M25 X 1.5	M25 X 1.5
780DM4M45	M32 X 1.5	M32 X 1.5
780DM5M55	M40 X 1.5	M40 X 1.5
780DT1T15	1/2"	1/2"
780DT2T25	3/4"	3/4"
780DTIM25	1/2"	M20 X 1.5
780DT2M35	3/4"	M25 X 1.5

Dimensions are displayed in inches unless otherwise stated. Alternative threads available.

784

AEEx e Ex e AEEx d Ex d AEEx t Ex t

45° SWIVEL UNIONS

- Allows the connection of conduit or glands to equipment
- Male / male & female / female threads available
- Suitable for rigid or flexible conduit
- Eliminates the need to rotate the conduit
- RapidEx barrier version available
- Equipment interface 'O' ring seal available
- 76°F to 392°F
- Globally marked, IECEX, ATEX & cCSAus



DESIGN SPECIFICATION	BS 6121:Part 1:1989
ENCLOSURE PROTECTION	IK10 to IEC 62262 (20 joules) Brass & Stainless Steel only
ATEX CERTIFICATE	CML 18ATEX1329U
CODE OF PROTECTION	Ⓜ II 2G ID Ex db IIC Gb, Ex eb IIC Gb, Ex ta IIIC Da IP6X Ⓜ IM2 Ex db I Mb / Ex eb I Mb
IECEX CERTIFICATE	IECEX CML 18.0186U
CODE OF PROTECTION	Ex db IIC Gb, Ex eb IIC Gb, Ex ta IIIC Da IP6X, Ex db I Mb, Ex eb I Mb
cCSAus CERTIFICATE	1055233
CODE OF PROTECTION	Class I, Div 1 & 2, Groups A,B,C,D ; Enclosure type 4X : Class I, Zone 1, AEx de II ; Ex de II

EXAMPLE ORDERING REFERENCE	BARRIER EXAMPLE ORDERING REFERENCE	FIRST THREAD	SECOND THREAD
784DM2M25	PX784REXIDXM2M25	M20 X 1.5	M20 X 1.5
784DM3M35	PX784REXIDXM3M35	M25 X 1.5	M25 X 1.5
784DM4M45	PX784REXIDXM4M45	M32 X 1.5	M32 X 1.5
784DM5M55	PX784REXIDXM5M55	M40 X 1.5	M40 X 1.5
784DM6M65	PX784REXIDXM6M65	M50 X 1.5	M50 X 1.5
784DM7M75	PX784REXIDXM7M75	M63 X 1.5	M63 X 1.5
784DTIM25	PX784REXIDXTIM25	1/2"	M20 X 1.5
784DT2M35	PX784REXIDXT2M35	3/4"	M25 X 1.5
784DT1T15	PX784REXIDXT1T15	1/2"	1/2"
784DT2T25	PX784REXIDXT2T25	3/4"	3/4"

Dimensions are displayed in inches unless otherwise stated. Alternative threads available.

PX780REX

AEEx e Ex e AEEx d Ex d AEEx t Ex t



IN-LINE BARRIER UNIONS WITH RAPIDEX

- Allows the connection of conduit or glands to equipment
- Suitable for rigid or flexible conduit
- Eliminates the need to rotate the conduit
- Equipment interface 'O' ring seal available
- 76°F to 185°F
- Globally marked, IECEX, ATEX & cCSAus
- Available with epoxy barrier compound (PX780)



DESIGN SPECIFICATION	BS 6121:Part 1:1989
ENCLOSURE PROTECTION	IK10 to IEC 62262 (20 joules) Brass & Stainless Steel only
ATEX CERTIFICATE	CML 18ATEX1329U
CODE OF PROTECTION	Ⓜ II 2G ID Ex db IIC Gb, Ex eb IIC Gb, Ex ta IIIC Da IP6X Ⓜ IM2 Ex db I Mb / Ex eb I Mb
IECEX CERTIFICATE	IECEX CML 18.0186U
CODE OF PROTECTION	Ex db IIC Gb, Ex eb IIC Gb, Ex ta IIIC Da IP6X, Ex db I Mb, Ex eb I Mb
cCSAus CERTIFICATE	1055233
CODE OF PROTECTION	Class I, Div 1 & 2, Groups A,B,C,D ; Enclosure type 4X : Class I, Zone 1, AEx de II ; Ex de II

RAPIDEX EXAMPLE ORDERING REFERENCE	EPOXY COMPOUND EXAMPLE ORDERING REFERENCE	FIRST THREAD SIZE	SECOND THREAD SIZE
PX780REXIDXM2M25	PX780DM2M25	M20 X 1.5	M20 X 1.5
PX780REXIDXM3M35	PX780DM3M35	M25 X 1.5	M25 X 1.5
PX780REXIDXM4M45	PX780DM4M45	M32 X 1.5	M32 X 1.5
PX780REXIDXM5M55	PX780DM5M55	M40 X 1.5	M40 X 1.5
PX780REXIDXT1T15	PX780DT1T15	1/2"	1/2"
PX780REXIDXT2T25	PX780DT2T25	3/4"	3/4"
PX780REXIDXTIM25	PX780DTIM25	1/2"	M20 X 1.5
PX780REXIDXT2M35	PX780DT2M35	3/4"	M25 X 1.5

Dimensions are displayed in inches unless otherwise stated. Alternative threads available.

789

AEEx e Ex e AEEx d Ex d AEEx t Ex t

90° SWIVEL UNIONS

- Allows the connection of conduit or glands to equipment
- Male / male & female / female threads available
- Suitable for rigid or flexible conduit
- Eliminates the need to rotate the conduit
- RapidEx barrier version available
- Equipment interface 'O' ring seal available
- 76°F to 392°F
- Globally marked, IECEX, ATEX & cCSAus



DESIGN SPECIFICATION	BS 6121:Part 1:1989
ENCLOSURE PROTECTION	IK10 to IEC 62262 (20 joules) Brass & Stainless Steel only
ATEX CERTIFICATE	CML 18ATEX1329U
CODE OF PROTECTION	Ⓜ II 2G ID Ex db IIC Gb, Ex eb IIC Gb, Ex ta IIIC Da IP6X Ⓜ IM2 Ex db I Mb / Ex eb I Mb
IECEX CERTIFICATE	IECEX CML 18.0186U
CODE OF PROTECTION	Ex db IIC Gb, Ex eb IIC Gb, Ex ta IIIC Da IP6X, Ex db I Mb, Ex eb I Mb
cCSAus CERTIFICATE	1055233
CODE OF PROTECTION	Class I, Div 1 & 2, Groups A,B,C,D ; Enclosure type 4X : Class I, Zone 1, AEx de II ; Ex de II

EXAMPLE ORDERING REFERENCE	BARRIER EXAMPLE ORDERING REFERENCE	FIRST THREAD	SECOND THREAD
789DM2M25	PX789REXIDXM2M25	M20 X 1.5	M20 X 1.5
789DM3M35	PX789REXIDXM3M35	M25 X 1.5	M25 X 1.5
789DM4M45	PX789REXIDXM4M45	M32 X 1.5	M32 X 1.5
789DM5M55	PX789REXIDXM5M55	M40 X 1.5	M40 X 1.5
789DM6M65	PX789REXIDXM6M65	M50 X 1.5	M50 X 1.5
789DM7M75	PX789REXIDXM7M75	M63 X 1.5	M63 X 1.5
789DTIM25	PX789REXIDXTIM25	1/2"	M20 X 1.5
789DT2M35	PX789REXIDXT2M35	3/4"	M25 X 1.5
789DT1T15	PX789REXIDXT1T15	1/2"	1/2"
789DT2T25	PX789REXIDXT2T25	3/4"	3/4"

Dimensions are displayed in inches unless otherwise stated. Alternative threads available.

747 757 767

AEEx e Ex e AEEx d Ex d AEEx t Ex t

STOPPER PLUGS

- Available in dome, hexagon & recessed heads
- Provides means of blanking unused cable entries
- Temporary or permanent
- Tamper-proof version available
- General purpose / industrial version available
- Nylon Ex e only version available (-4°F to +140°F)
- 76°C to 392°F (metallic versions)
- Globally marked, IECEX, ATEX, cCSAus & UL NPT threads available



DESIGN SPECIFICATION	BS 6121:Part 1:1989
ENCLOSURE PROTECTION	IK10 to IEC 62262 (20 joules) Brass & Stainless Steel Only
ATEX CERTIFICATE	CML 18ATEX1320X
CODE OF PROTECTION	Ⓜ II 2G Ex db IIC Gb, Ex eb IIC Gb, II 1D Ex ta IIIC Da Ⓜ IM2 Ex db I Mb, Ex eb I Mb (II 2G Ex eb IIC Gb, II 1D Ex ta IIIC Da only on Nylon version)
IECEX CERTIFICATE	IECEX CML 18.0177X
CODE OF PROTECTION	Ex db I Mb, Ex eb I Mb; Ex db IIC Gb, Ex eb IIC Gb, Ex ta IIIC Da
cCSAus CERTIFICATE	1055233
CODE OF PROTECTION	Ex e II, Class I, Zone 1, AEx e II; IP66, 67, 68; Enclosure Type 4X; Class II Groups E, F and G; Class III
UL CERTIFICATE	E214221
CODE OF PROTECTION	Class I Div 1 & 2, Groups A,B,C,D; Class II Groups E,F,G; Class III

747 - THREAD SIZE	747 - RECESSED	757 - THREAD SIZE	757 - HEXAGON	767 - THREAD SIZE	767 - DOME
1/2"	747DAT15	1/2"	757DT15	1/2"	767DT15
3/4"	747DAT25	3/4"	757DT25	3/4"	767DT25
1"	747DAT35	1"	757DT35	1"	767DT35
1-1/4"	747DAT45	1-1/4"	757DT45	1-1/4"	767DT45
1-1/2"	747DAT55	1-1/2"	757DT55	1-1/2"	767DT55
M16	747DAM15	M16	757DM15	M16	767DM15
M20	747DAM25	M20	757DM25	M20	767DM25
M25	747DAM35	M25	757DM35	M25	767DM35
M32	747DAM45	M32	757DM45	M32	767DM45
M40	747DAM55	M40	757DM55	M40	767DM55

Dimensions are displayed in inches unless otherwise stated. Alternative threads available.

ENTRY THREAD SEALING WASHERS

To maintain the Ingress Protection rating between the equipment and the Cable Gland, it may be necessary to fit an Entry Thread Sealing Washer at the equipment-to-gland entry interface. For installations it is equally essential to maintain the ingress protection integrity at which the equipment has been rated.

The need for a sealing washer will depend on the ingress protection rating, code of protection of the equipment and the type of entry holes available within that equipment. For example, when using Ex e equipment or terminal enclosures (which are permitted to have untapped through-clearance holes) it will be necessary to fit a sealing washer to ensure the minimum IP54 requirement is met. Other equipment with tapped entry holes may not require a sealing washer to maintain the IP54 minimum rating.

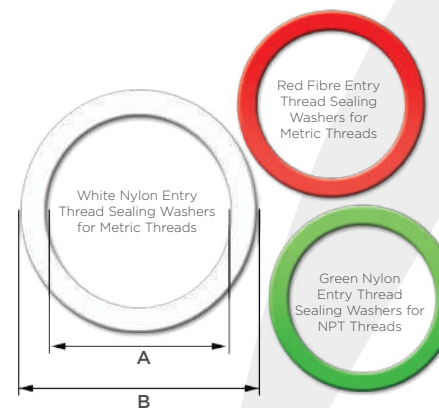

781

AEEx e Ex e AEEx d Ex d AEEx t Ex t

BREATHER / DRAINS

- 781E for Ex e use
- 781D for Ex d use
- Drains equipment susceptible to moisture collection
- Enables equipment to breathe
- Nylon Ex e only version available (-4°F to +140°F)
- 76°C to 392°F (metallic versions)
- Globally marked, IECEX, ATEX & cCSAus
- NPT threads available



DESIGN SPECIFICATION	BS 6121:Part 1:1989
ENCLOSURE PROTECTION	IK10 to IEC 62262 (20 joules) Brass & Stainless Steel Only
ATEX CERTIFICATE	CML 18ATEX1327X
CODE OF PROTECTION	781D: Ⓜ II 2G Ex db IIC Gb, II 1D Ex ta IIIC Da 781E: Ⓜ II 2G Ex eb IIC Gb, II 1D Ex ta IIIC Da
IECEX CERTIFICATE	IECEX CML 18.0187U
CODE OF PROTECTION	781D: Ex db IIC Gb, Ex ta IIIC Da 781E: Ex eb IIC Gb, Ex ta IIIC Da
cCSAus CERTIFICATE	1055233
CODE OF PROTECTION	781D: Ex d IIC, Class I, Zone 1 AEx d IIC; Class I Div 1, Groups A,B,C,D IP66, Enclosure Type 4X 781E: Ex e II, Class I, Zone 1, AEx e II IP66, Enclosure Type 4X
UL CERTIFICATE	E253914
CODE OF PROTECTION	781D: Class I, Zone 1, AEx d IIB or IIC; Zone 20, AEx ta IIIC 781E: Class I, Zone 1, AEx e IIC

ORDERING REFERENCE 781D	ORDERING REFERENCE 781E	THREAD SIZE
781DT15	781ET15	1/2"
781DT25	781ET25	3/4"
781DM15	781EM15	M20
781DM25	781EM25	M25
781DT24 (Stainless Steel)	781ET24 (Stainless Steel)	1/2"
781DT34 (Stainless Steel)	781ET34 (Stainless Steel)	3/4"

Dimensions are displayed in inches unless otherwise stated. Alternative threads available.

ORDERING REFERENCE (METRIC)	REFERENCE DIAMETER 'A'	MINIMUM THICKNESS	EXTERNAL DIAMETER 'B'
16ETS2	M16	0.08	1.00
20ETS2	M20	0.08	1.10
25ETS2	M25	0.08	1.35
32ETS2	M32	0.08	1.74
40ETS2	M40	0.08	1.99
50ETS2	M50	0.08	2.50
63ETS2	M63	0.08	3.01
75ETS2	M75	0.08	3.74
90ETS2	M90	0.08	4.33

ORDERING REFERENCE (NPT)	REFERENCE DIAMETER 'A'	MINIMUM THICKNESS	EXTERNAL DIAMETER 'B'
050NPTETS	1/2" NPT	0.08	1.10
075NPTETS	3/4" NPT	0.08	1.35
100NPTETS	1" NPT	0.08	1.74
125NPTETS	1 1/4" NPT	0.08	1.99
150NPTETS	1 1/2" NPT	0.08	2.50
200NPTETS	2" NPT	0.08	3.01
250NPTETS	2 1/2" NPT	0.08	3.74
300NPTETS	3" NPT	0.08	4.33
400NPTETS	4" NPT	0.08	5.38

Dimensions shown are in inches unless otherwise stated

GROUNDING LOCKNUTS

CMP Products' Grounding locknuts for use with cable glands, conduit fittings, tubing (EMT) fittings and conduit as a means of reliably and safely bonding the locknut (and gland) to the enclosure or equipment.

Providing electrical continuity and tested to the requirements of CEC and NEC wiring codes CMP's grounding locknuts reduce the chance of equipment failure, downtime, power interruptions and eliminate potential safety issues.

Grounding locknuts are available with either a grounding terminal or lay-in lug and are available in stainless steel (GRLN4), aluminum (GRLN1) and nickel plated brass (GRLN5), e.g 20GRLN4 for M20 Stainless Steel Grounding Locknut.

NPT grounding locknuts are supplied as standard in aluminum and Metric in nickel plated brass. Hammer and screwdriver installation grooves only on aluminium design (as pictured).

STANDARD - SMALL LAY-IN LUG - 14-4 AWG
OPTIONAL - MEDIUM LAY-IN LUG - 14-2/0 AWG
OPTIONAL - LARGE LAY-IN LUG - 6-250 AWG

AWG - American wire gauge

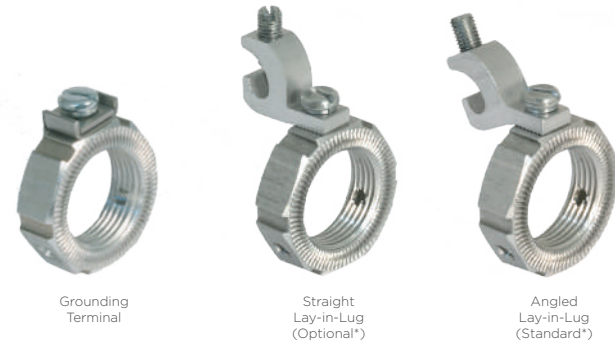

CCSAUS CERTIFICATE	2450309
CODE OF PROTECTION	Class I Zone 1 AExe II, Exe II
CLASS CATEGORIES	
C441404	Grounding and Bonding Devices
C441484	Grounding and Bonding Devices - Certified to US Standards
C909801	Miscellaneous - For Hazardous Locations
C909881	Miscellaneous - For Hazardous Locations - Certified to US Standards

NPT							
ORDERING REFERENCE ALUMINUM WITH ANGLED LAY-IN LUG			THREAD DIAMETER NPT	MINIMUM LOCKNUT THICKNESS 14-4 & 14-2/0 LUG	MINIMUM LOCKNUT THICKNESS 6-250 LUG	ACROSS FLATS DIMENSION	ACROSS CORNERS DIAMETER
STANDARD 14-4 AWG	OPTIONAL 14-2/0 AWG	OPTIONAL 6-250 AWG*					
050NPTGRLN14A	-	-	1/2"	0.48	-	1.20	1.32
075NPTGRLN14A	-	-	3/4"	0.48	-	1.48	1.63
100NPTGRLN14A	100NPTGRLN110A	-	1"	0.48	-	1.81	1.99
125NPTGRLN14A	125NPTGRLN110A	-	1 1/4"	0.48	-	2.05	2.25
150NPTGRLN14A	150NPTGRLN110A	-	1 1/2"	0.48	-	2.36	2.60
200NPTGRLN14A	200NPTGRLN110A	-	2"	0.48	-	2.76	3.03
250NPTGRLN14A	250NPTGRLN110A	250NPTGRLN125	2 1/2"	0.48	0.68	3.54	3.90
300NPTGRLN14A	300NPTGRLN110A	300NPTGRLN125	3"	0.48	0.68	4.33	4.76
350NPTGRLN14A	350NPTGRLN110A	350NPTGRLN125	3 1/2"	0.48	0.68	4.84	5.33
400NPTGRLN14A	400NPTGRLN110A	400NPTGRLN125	4"	0.48	0.68	5.24	5.76

Dimensions shown are in inches unless otherwise stated

Grounding Locknuts with Lay-in-Lug are available in Nickel Plated Brass & Stainless Steel. Lay-in-Lug will always be Aluminum regardless of locknut material. Lay-in-Lug may be angled or straight design, remove 'A' suffix from order reference for straight design. *Only the straight lay-in-lug design is available for 6-250 AWG.

METRIC					
ORDERING REFERENCE WITH GROUNDING TERMINAL		THREAD DIAMETER METRIC	MINIMUM THICKNESS	ACROSS FLATS DIMENSION	ACROSS CORNERS DIAMETER
STANDARD NICKEL PLATED BRASS	OPTIONAL STAINLESS STEEL				
20GRLN5	20GRLN4	M20	0.48	1.20	1.32
25GRLN5	25GRLN4	M25	0.48	1.48	1.63
32GRLN5	32GRLN4	M32	0.48	1.81	1.99
40GRLN5	40GRLN4	M40	0.48	2.05	2.25
50GRLN5	50GRLN4	M50	0.48	2.36	2.60
63GRLN5	63GRLN4	M63	0.48	2.76	3.03
75GRLN5	75GRLN4	M75	0.48	3.54	3.90
90GRLN5	90GRLN4	M90	0.48	4.33	4.76
100GRLN5	100GRLN4	M100	0.48	4.84	5.33
115GRLN5	115GRLN4	M115	0.48	5.24	5.76

Dimensions shown are in inches unless otherwise stated

Grounding Terminal will always be Stainless Steel regardless of locknut material. Grounding Terminal is suitable for wire sizes 0.5mm2 to 2.5mm2.

STANDARD LOCKNUTS

Nickel Plated Brass - Recommended in securing brass Cable Glands and Accessories to a gland plate or into equipment.

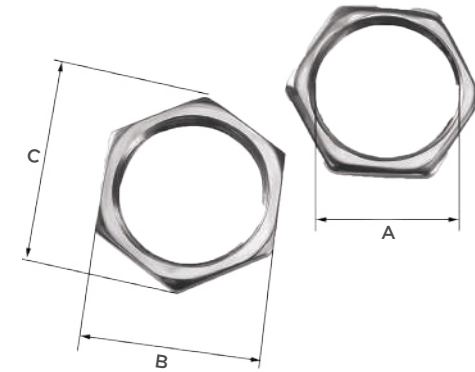

In metric thread form CMP offers brass locknuts in a choice of standard duty and heavy duty options for sizes up to and including M32. The part numbers are distinguished by an additional letter H, e.g. 20LN = standard duty, and 20HLN = heavy duty. From size M40 all brass metric locknuts are considered to be heavy duty.

Aluminum - Recommended when installing aluminum Cable Glands to prevent the galvanic corrosion which can occur when dissimilar metals are coupled together.

Ordering references shown in Nickel Plated Brass.

CONDUIT LOCKNUTS

Conduit Locknuts act as an anti-vibration device preventing the cable gland or accessory from inadvertently loosening in service.

Zinc Plated Mild Steel - A cost effective locknut recommended when using nickel plated Cable Glands, should be used only in dry, low humidity conditions.

Aluminium - Recommended when installing aluminium Cable Glands to prevent the galvanic corrosion which can occur when dissimilar metals are coupled together.

METRIC				
ORDERING REFERENCE (METRIC)	THREAD DIAMETER 'A'	MINIMUM THICKNESS	ACROSS FLATS DIMENSION 'B'	ACROSS CORNERS DIAMETER 'C'
16LN5	M16 X 1.5	0.13	0.87	1.00
20LN5	M20 X 1.5	0.13	0.94	1.09
25LN5	M25 X 1.5	0.13	1.18	1.36
32LN5	M32 X 1.5	0.13	1.42	1.64
40LN5	M40 X 1.5	0.19	1.81	2.09
50LN5	M50 X 1.5	0.25	2.17	2.50
63LN5	M63 X 1.5	0.25	2.76	3.18
75LN5	M75 X 1.5	0.25	3.31	3.82
90LN5	M90 X 2.0	0.37	4.17	4.82
100LN5	M100 X 2.0	0.37	4.84	5.59

NPT				
ORDERING REFERENCE (NPT)	THREAD DIAMETER 'A'	MINIMUM THICKNESS	ACROSS FLATS DIMENSION 'B'	ACROSS CORNERS DIAMETER 'C'
050NPTLN5	1/2" NPT	0.19	1.06	1.23
075NPTLN5	3/4" NPT	0.19	1.30	1.50
100NPTLN5	1" NPT	0.19	1.61	1.86
125NPTLN5	1 1/4" NPT	0.19	1.97	2.27
150NPTLN5	1 1/2" NPT	0.20	2.36	2.73
200NPTLN5	2" NPT	0.20	2.95	3.49
250NPTLN5	2 1/2" NPT	0.39	3.31	3.82
300NPTLN5	3" NPT	0.39	3.94	4.55
350NPTLN5	3 1/2" NPT	0.44	4.50	5.20
350NPTLN5	4" NPT	0.47	5.12	5.91

Dimensions shown are in inches unless otherwise stated

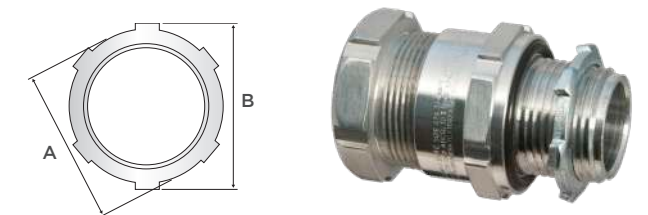

TC Cable Gland shown as example

NPT						
ORDERING REFERENCE (ALUMINIUM)	ORDERING REFERENCE (GALVANIZED / ZINC PLATED STEEL)	ORDERING REFERENCE (STAINLESS STEEL)	NPT THREAD DIAMETER	MINIMUM THICKNESS	ACROSS CASTELLATION 'B'	ACROSS DIAMETER 'A'
050NPTCLN1	050NPTCLN6	050NPTCLN4	1/2"	0.10	1.13	1.00
075NPTCLN1	075NPTCLN6	075NPTCLN4	3/4"	0.10	1.39	1.26
100NPTCLN1	100NPTCLN6	100NPTCLN4	1"	0.13	1.71	1.57
125NPTCLN1	125NPTCLN6	125NPTCLN4	1 1/4"	0.17	2.07	1.90
150NPTCLN1	150NPTCLN6	150NPTCLN4	1 1/2"	0.17	2.36	2.17
200NPTCLN1	200NPTCLN6	200NPTCLN4	2"	0.17	2.86	2.68
250NPTCLN1	250NPTCLN6	250NPTCLN4	2 1/2"	0.17	3.43	3.25
300NPTCLN1	300NPTCLN6	300NPTCLN4	3"	0.17	4.11	3.95
350NPTCLN1	350NPTCLN6	350NPTCLN4	3 1/2"	0.17	4.69	4.49
400NPTCLN1	400NPTCLN6	400NPTCLN4	4"	0.17	5.27	5.00

All dimension shown are in inches unless otherwise stated

SERRATED WASHERS

Available in Stainless Steel, these 'shake-proof' Serrated Washers can be fitted internally to the equipment before a locknut and act as an anti-vibration device to prevent the Cable Gland or accessory from inadvertently loosening in service.

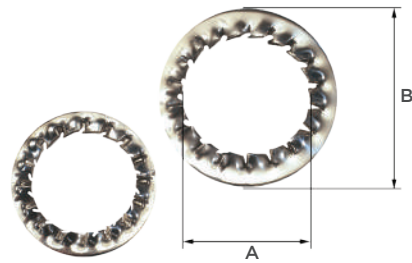

In typical installations that are not subject to vibration, a serrated washer may not be required but consideration should be given to the following statement:

Self-loosening should be avoided according to clause 6.4.1 of IEC 60079-14, this can occur through relative motion over time even without vibration, due to differential thermal effects caused as a result of either differences in temperature or differences in clamped materials.

Ordering references shown in Stainless Steel.

ORDERING REFERENCE (METRIC)	REFERENCE DIAMETER 'A'	MINIMUM THICKNESS	EXTERNAL DIAMETER 'B'
16SW4	M16	0.15	1.00
20SW4	M20	0.15	1.28
25SW4	M25	0.15	1.57
32SW4	M32	0.15	1.71
40SW4	M40	0.15	2.54
50SW4	M50	0.15	3.15
63SW4	M63	0.15	3.94
75SW4	M75	0.16	4.41
90SW4	M90	0.16	5.31
100SW4	M100	0.16	5.71

ORDERING REFERENCE (NPT)	REFERENCE DIAMETER 'A'	MINIMUM THICKNESS	EXTERNAL DIAMETER 'B'
050NPTSW4	½" NPT	0.15	1.28
075NPTSW4	¾" NPT	0.15	1.57
100NPTSW4	1" NPT	0.15	1.71
125NPTSW4	1¼" NPT	0.15	2.54
150NPTSW4	1 ½" NPT	0.15	3.15
200NPTSW4	2" NPT	0.15	3.94
250NPTSW4	2 ½" NPT	0.15	4.41
300NPTSW4	3" NPT	0.16	5.31
350NPTSW4	3 ½" NPT	0.16	5.71
400NPTSW4	4" NPT	0.16	7.28

Dimensions shown are in inches unless otherwise stated

EARTH TAGS

CMP slip on Earth Tags, installed between the Cable Gland and equipment, provide an earth bond connection. Earth Tags have been independently short circuit tested to verify their suitability under specified service conditions. A copy of the test report is available upon request and is an important factor when selecting earth tags from any manufacturer, as without this the safety of installations may be compromised.

METRIC	NPT	SHORT CIRCUIT RATINGS SYMMETRICAL FAULT CURRENT (KA) FOR 1 SECOND
20	¾"	3.06
25	1"	4.06
32	1¼"	5.40
40	1 ½"	7.20
50	2"	10.40
63	2 ½"	10.40
75	3"	10.40

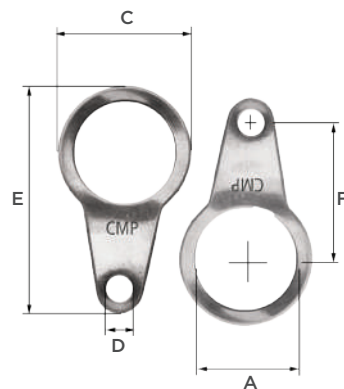

Stainless steel, aluminum and nickel plated brass earth tags are available. Please refer to ordering reference numbers, e.g. 20ET4 for M20 Stainless Steel Earth Tag, 050NPTET4 for ½" NPT Stainless Steel Earth Tag.

Ordering references shown in Nickel Plated Brass.

ORDERING REFERENCE (METRIC)	REFERENCE DIAMETER 'A'	MINIMUM THICKNESS	NOMINAL DIAMETER 'C'	HOLE SIZE 'D'	NOMINAL LENGTH 'E'	NOMINAL CENTRES 'F'
16ET5	M16	0.05	1.00	M6	1.98	1.19
20ET5	M20	0.05	1.07	M6	2.06	1.30
25ET5	M25	0.06	1.38	M6	2.33	1.40
32ET5	M32	0.06	1.78	M12	3.03	1.70
40ET5	M40	0.06	2.11	M13	3.49	1.79
50ET5	M50	0.06	2.57	M13	4.38	2.29
63ET5	M63	0.06	3.25	M13	5.07	2.63
75ET5	M75	0.06	3.76	M13	5.57	2.87
90ET5	M90	0.08	4.50	M13	6.34	3.35
100ET5	M100	0.08	4.92	M13	7.67	4.65

ORDERING REFERENCE (NPT)	REFERENCE DIAMETER 'A'	MINIMUM THICKNESS	NOMINAL DIAMETER 'C'	HOLE SIZE 'D'	NOMINAL LENGTH 'E'	NOMINAL CENTRES 'F'
050NPTET5	½" NPT	0.05	1.07	M6	2.08	1.30
075NPTET5	¾" NPT	0.06	1.38	M6	2.33	1.40
100NPTET5	1" NPT	0.06	1.78	M12	3.03	1.70
125NPTET5	1¼" NPT	0.06	2.11	M13	3.49	1.79
150NPTET5	1 ½" NPT	0.06	2.57	M13	4.38	2.29
200NPTET5	2" NPT	0.06	3.25	M13	5.07	2.63
250NPTET5	2 ½" NPT	0.06	3.76	M13	5.57	2.87
300NPTET5	3" NPT	0.08	4.49	M13	6.34	3.35
350NPTET5	3 ½" NPT	0.08	4.92	M13	7.67	4.06
400NPTET5	4" NPT	0.08	5.53	M13	8.15	4.64

Dimensions shown are in inches unless otherwise stated

NPT CABLE GLAND WRENCHES

When installing cable glands and accessories it is important that the correct tools are used to carry out the installation. This includes the use of the correct cable gland wrench specifically designed to fit each individual product to minimise the potential for accidental injury caused by slippage, as can be the case with adjustable wrenches.



Metric wrenches available upon request.

CABLE GLAND SIZE	THREAD SIZE	A**		T3CDS				PXSS2K			C2KX			PX**			THREAD SIZE	CABLE GLAND SIZE	TC	
		WRENCH 1	WRENCH 2	WRENCH 1	WRENCH 2	WRENCH 3	WRENCH 4	WRENCH 1	WRENCH 2	WRENCH 3	WRENCH 1	WRENCH 2	WRENCH 3	WRENCH 1	WRENCH 2	WRENCH 3			WRENCH 1	WRENCH 2
20S16	½"	SP2	SP1	SP2	SP2	SP2	SP3	SP4	SP3	-	SP4	SP4	-	SP4	SP4	-	½"	028	SP4	SP4
	¾"	SP4	SP1	SP6	SP2	SP2	-	SP4	SP3	-	SP5	SP4	SP4	SP4	SP4	-	¾"	028	SP7	SP4
20S	½"	SP2	SP1	SP2	SP2	SP3	-	SP4	SP3	-	SP4	SP4	-	SP4	SP4	-	½"	055	SP4	SP4
	¾"	SP6	SP1	SP6	SP2	SP2	-	SP4	SP3	-	SP5	SP4	SP2	SP4	SP4	-	¾"	055	SP7	SP4
20	½"	SP3	SP2	SP4	SP4	-	-	SP4	SP3	SP3	SP4	SP4	-	SP4	SP4	-	½"	079	SP7	SP7
	¾"	SP4	SP2	SP4	SP4	-	-	SP4	SP3	SP3	SP4	SP4	-	SP4	SP4	-	¾"	079	SP11	SP11
25 / 25S	¾"	SP9	SP9	SP7	SP7	-	-	SP9	SP9	-	SP7	SP7	-	SP7	SP7	-	1"	104	SP11	SP11
	1"	SP9	SP9	SP7	SP7	-	-	SP9	SP9	-	SP7	SP7	-	-	-	-	1"	104	SP16	SP12
32	1"	SP12	SP6	SP11	SP11	-	-	SP12	SP12	-	SP11	SP11	-	SP12	SP12	-	1-¼"	127	SP16	SP16
	1-¼"	SP12	SP8	SP11	SP11	-	-	SP12	SP12	-	SP11	SP11	-	SP12	SP12	-	1-½"	127	SP18	SP16
40	1-¼"	SP13	SP13	SP14	SP14	-	-	SP13	SP13	-	SP14	SP14	-	SP14	SP14	-	1-½"	150	SP18	SP18
	1-½"	SP13	SP13	SP14	SP14	-	-	SP13	SP13	-	SP14	SP14	-	SP14	SP14	-	2"	150	SP20	SP18
50S	1-½"	SP14	SP14	SP18	SP16	SP18	-	SP14	SP14	-	SP18	SP18	-	SP18	SP18	-	2"	174	SP20	SP18
	2"	SP14	SP14	SP19	SP16	SP18	SP18	SP19	SP14	SP14	SP20	SP18	SP18	SP19	SP18	SP18	2-½"	174	SP24	SP18
50	2"	SP19	SP18	SP20	SP18	SP20	-	SP20	SP18	SP18	SP20	SP20	-	SP20	SP20	-	2"	197	SP20	SP20
	2-½"	SP22	SP18	SP22	SP20	SP20	SP18	SP22	SP18	SP18	SP22	SP20	SP20	SP22	SP20	SP20	2-½"	197	SP24	SP20
63S	2"	SP20	SP19	SP21	SP19	SP21	-	SP20	SP20	-	SP21	SP21	-	SP21	SP21	-	2-½"	220	SP24	SP21
	2-½"	SP22	SP19	SP22	SP19	SP21	SP21	SP22	SP20	SP20	SP21	SP21	-	SP21	SP21	-	3"	220	SP26	SP21
63	2-½"	SP22	SP20	SP22	SP20	SP22	-	SP22	SP21	SP21	SP22	SP22	-	SP22	SP22	-	2-½"	244	SP24	SP24
	3"	SP25	SP20	SP25	SP22	SP22	SP20	-	-	-	SP25	SP22	SP22	SP25	SP22	SP22	3"	244	SP26	SP24
75S	2-½"	SP22	SP22	SP24	SP22	SP24	-	SP22	SP22	-	SP24	SP24	-	SP24	SP24	-	3"	268	SP26	SP24
	3"	SP25	SP22	SP25	SP22	SP24	SP24	SP25	SP22	SP22	SP24	SP24	-	SP24	SP24	-	3-½"	268	SP36	SP26
75	3"	SP25	SP23	SP25	SP23	SP25	-	SP25	SP23	SP23	SP25	SP25	-	SP25	SP25	-	4"	315	SP30	SP26
	3-½"	SP35	SP35	SP27	SP25	SP27	-	SP35	SP35	-	SP27	SP27	-	SP27	SP27	-				
90	4"	SP35	SP35	SP29	SP29	SP36	SP26	-	-	-	SP30	SP27	SP27	SP30	SP27	SP27				
	4"	SP36	SP35						SP36	SP36	-	-	-	SP30	SP29	SP36				
100	4"																			
115	4"	SP30	SP37																	

THREAD & CABLE GLAND SIZE	TMC/TMCX		THREAD SIZE	CABLE GLAND SIZE	TMC2		TMC2X			THREAD SIZE	CABLE GLAND SIZE	TMC2		TMC2X		
	WRENCH 1	WRENCH 2			WRENCH 1	WRENCH 2	WRENCH 3	WRENCH 1	WRENCH 2			WRENCH 1	WRENCH 2	WRENCH 3		
050S	SP4	SP4	050	075	SP04	SP04	SP04	SP04	-	200	200	SP21	SP20	SP18	SP20	SP21
050	SP9	SP9	075	075	SP04	SP07	SP04	SP04	-	150	233	SP21	SP21	SP19	SP21	SP21
075	SP8	SP8	050	099	SP07	SP07	SP04	SP07	SP07	200	233	SP21	SP21	SP19	SP21	SP21
100	SP13	SP13	075	099	SP07	SP07	SP04	SP07	SP07	250	233	SP24	SP21	SP19	SP21	SP24
125	SP14	SP14	075	118	SP11	SP11	SP07	SP11	SP11	200	272	SP24	SP24	SP21	SP24	SP24
150	SP18	SP18	100	118	SP11	SP11	SP01	SP11	SP11	250	272	SP24	SP24	SP22	SP24	SP24
200S	SP20	SP20	100	137	SP16	SP16	SP16	SP16	SP40	300	272	SP24	SP26	SP22	SP24	SP26
200	SP21	SP21	125	137	SP16	SP16	SP16	SP16	SP40	300	325	SP26	SP26	SP26	SP26	SP34
250S	SP22	SP22	125	162	SP18	SP18	SP13	SP18	SP18	350	325	SP26	SP36	SP26	SP26	SP34
250	SP23	SP23	150	162	SP18	SP18	SP13	SP18	SP18	350	376	SP36	SP36	SP35	SP36	SP36
300	SP26	SP26	125	190	SP19	SP19	SP14	SP19	SP19	400	376	SP30	SP36	SP35	SP36	SP36
350	SP30	SP30	150	190	SP19	SP19	SP14	SP19	SP19	400	425	SP30	SP30	SP28	SP30	SP30
400	SP30	SP30	150	200	SP20	SP20	SP18	SP20	SP20							

ACCESSORIES

ACCESSORIES

About CMP

SECURING CABLES WORLDWIDE



At CMP Products, we owe our success to our commitment to quality, dedication to innovation and investment in our people.

As a market-leading specialist designer and manufacturer of cable glands, cable cleats and accessories, CMP has been providing safe and innovative solutions to the global market for over 60 years; gaining us an international reputation for quality and reliability.

Our products are developed to suit a wide range of hazardous and industrial applications; including industries such as mining, oil & gas, rail, pharmaceuticals and construction. They have been designed and rigorously tested to cover a variety of international codes, standards and approvals.

Our high-quality products are reinforced with exceptional customer service and innovative solutions; we offer on-hand technical support from our experts across the globe, from 10 different offices spread across 6 continents.

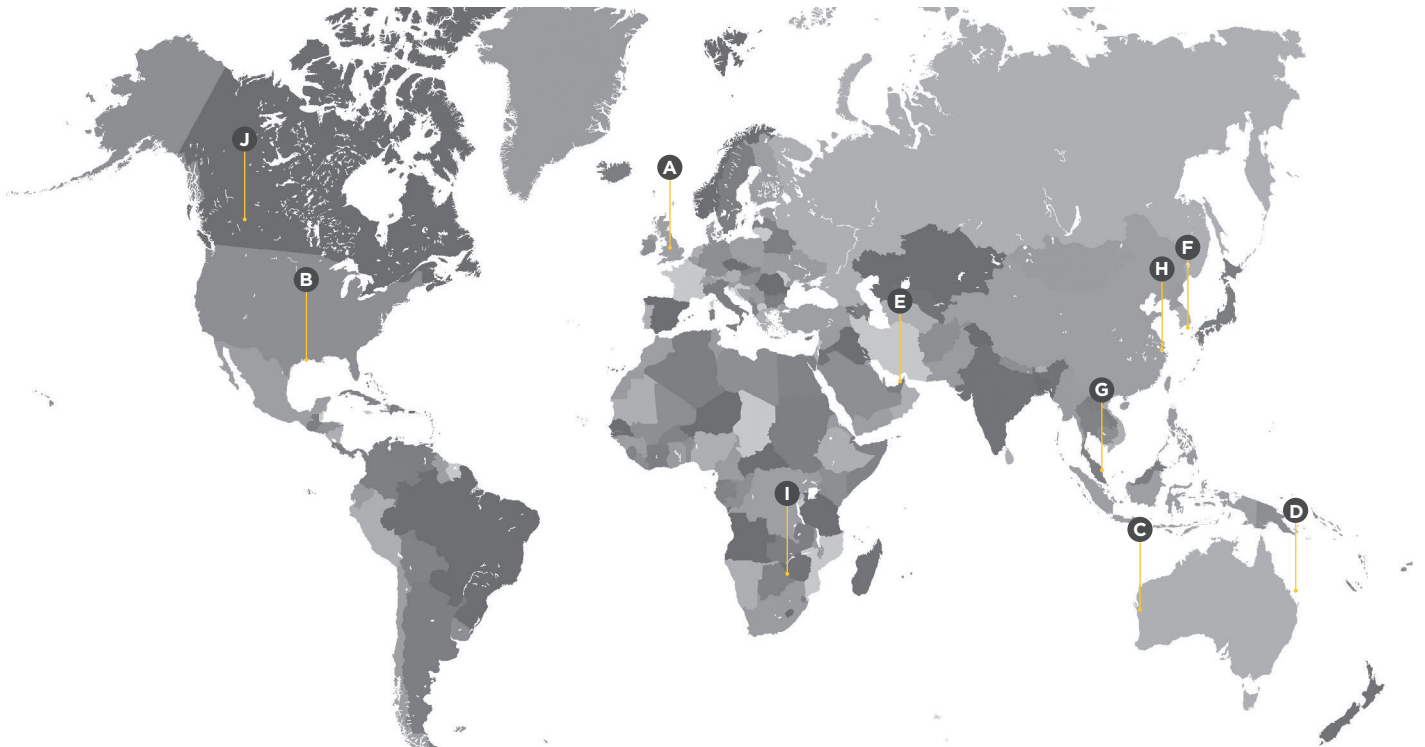

A NEWCASTLE (Headquarters)

CMP Products Limited
United Kingdom
Tel: +44 (0) 191 2657411
E-Mail:
customerservices@cmp-products.com

B HOUSTON (Texas Inc)
CMP Products Texas Inc

Texas, USA
Tel: +1 281 776 5201
E-Mail:
houstonoffice@cmp-products.com

C PERTH, WA
CMP Products Pty Ltd

Australia
Tel: +61 8 9249 4508
E-Mail: perthoffice@cmp-products.com

D BRISBANE, QLD
CMP Products Pty Ltd

Australia
Tel: +61 7 3801 0301
E-Mail: qldoffice@cmp-products.com

E DUBAI
CMP Products Middle East Office

United Arab Emirates
Tel: +971 4 214 6114
E-Mail: meoffice@cmp-products.com

F BUSAN
CMP Products (Korea) Ltd

South Korea
Tel: +82 51 780 5300
E-Mail: busanoffice@cmp-products.com

G SINGAPORE
CMP Products (S.E.A) Pte Ltd.

Singapore
Tel: +65 6466 6180
E-Mail: seaoffice@cmp-products.com

H SHANGHAI
CMP Products Division

P.R. China
Tel: +86 21 5837 9978
E-Mail:
shanghaioffice@cmp-products.com

I JOHANNESBURG
CMP Products

South Africa
Tel: +27 11 266 8880
E-Mail: africaoffice@cmp-products.com

J CANADA
CMP Products - New stock location

SFC3002 REV 6 07/23

www.cmp-products.com